



Window Film Manual



TABLE OF CONTENTS

Table of Contents	1-2	AFFINITY 15	41
Product Information	3-79	AFFINITY 30	42
Product Lines	4-6	SCLARL150	43
Prestige		SCLARL400	44
Night Vision		ULTRA600	45
Affinity		ULTRAS50	46
Sun Control		ULTRAS70	47
All Season		S20SIAR400	48
Safety		S25NVAR400	49
Automotive		S35NEAR400	50
Interior Design		S50NEAR400	51
Anti-Graffiti		SH4CLARL	52
Counter Intelligence		SH7CLARL	53
Identification System	7	SH8CLARL	54
Product Families	8-9	SH14CLARL	55
Product Performance Guides	10-18	CS-5	56
Single Clear Glass	11-12	CS-20	57
Single Tinted Glass	13-14	CS-35	58
Double Clear Glass	15-16	CS-50	59
Double Tinted Glass	17-18	BC-10	60
Details by Product	19-80	BC-20	61
LE35AMARL	20	BC-35	62
P-18ARL	21	BC-40	63
RE15SIARXL	22	FX HP-5	64
RE20BRARXL	23	FX HP-15	65
RE35NEARXL	24	FX HP-20	66
RE35SIARXL	25	FX HP-30	67
PRESTIGE 40	26	FX HP-35	68
PRESTIGE 50	27	FX HP-50	69
PRESTIGE 60	28	FX ST-5	70
PRESTIGE 70	29	FX ST-20	71
NV-15	30	FX ST-35	72
NV-25	31	FX ST-40	73
NV-35	32	FX ST-50	74
NV-45	33	CI100B	75
RE50NIARL	34	CI100T	76
RE20NEARL	35	Fasara	77-80
RE35NEARL	36		
RE50NEARL	37		
RE70NEARL	38		
RE35AMARL	39		
RE35SIARL	40		

TABLE OF CONTENTS continued

General Information	81-113	3. Creating Building Model with Film	143
How Film Works	82-108	4. Creating Energy Analysis Report	144
Electromagnetic Spectrum	83	5. Creating Graphs	145
Solar Spectrum	83	6. Other Topics	146
Wavelength	84	Table 2	147
Solar Radiation	84	Warranties	148-163
Total Solar Energy	85	US Warranty Information	149-151
Shading Coefficient	85	Program Details	149
Emissivity	86	Coverage	150-151
U Value/K Value	87	Warranty Application Form	152
R Value	87	Instructions	153-154
Calculate Solar Energy Reductions	88	Glass check list	155-156
Heat Transfer	89	Warranty Examples	157-163
British Thermal Unit	90	Installation	164-180
Methods of Heat Transfer	91	Flat Glass	165-174
Radiation	92	Tools & Equipment	165
Conduction	93	Tools & Equipment Inspection	166
Convection	94	Film Inspection	167
Solar Heat Gain	95	Inventory Card	168
Summer Heat Gain	96	Window Preparation	169
Ton - Hr	97	Clean and Glass and Frame	170
Winter Heat Loss	98	Film Application	171-173
Solar vs. Long Wave Radiation	99	Splicing	174
Top 20 Questions and Answers	99-104	Over Splice	175
Fading	105	Butt/Cut Through Splice	176
Longevity	106	Why Edge Seal	177
Storage Conditions	110	How to Edge Seal	178
EMI	109-113	Important details About Installation	179
Background and Definitions	110	Care and Cleaning	180-181
Test Results	111	Film Removal	182
Effects on House plants	112	Application Do's	183
Manufacturing Processes	113	Application Don'ts	184
Glass Types and Thermal Stress	114-126	Automotive	185-190
Glass Types	115-125	Tools & Equipment	185-186
Primary Glass Products	116-118	Process	187-188
Fabricated Glass Products	119-125	Color-Stable Installation	
Thermal Stress	126	Techniques	189-190
Edge Strength	126	Specifications	191-230
Will Scotchtint Break My Glass?	126	Prestige	192-196
Glass Checklist	127-135	Sun Control	197-200
Restrictions List	128	Night Vision	201-204
Breakage Warranty	129	All Season Low E	205-208
Instructions	130-132	Color Stable	209-212
Sample Form	133-134	Ultra High Performance	213-218
Expected Edge Stress Report	135	SH7CLARL	219-222
Energy Savings	136-147	SH8CLARL	223-226
3M AIMCAL Demand Analyzer		SH14CLARL	222-230
Installation	137-138	Glossary	231-239
Overview	139		
1. Using Templates Base Case Model	140		
2. Modify and Create Base Case Model	141		
Table 1	142		

3M Window Film

Product Information

3M™ Window Film

Product Lines

3M™ Prestige Window Films

With 3M™ Prestige Window Films, you can enjoy the benefits of a world-class window film while leaving the beauty of your windows virtually unchanged. Because 3M™ Prestige Window Films use no metals, they are not susceptible to corrosion in coastal environments and do not interfere with mobile phone reception. Other window films that reject heat tend to have high reflectivity, but not Prestige – Prestige Window Films offer reflectivity that is actually lower than glass. A final key technical feature of the Prestige line of products is that they were designed to perform best when the sun is high, at the hottest parts of the day so, when the sun is working hardest, our films are performing their best.

3M™ Night Vision Window Films

With 3M™ Night Vision Window Films, you get the exceptional performance of a reflective film while still being able to look through the film at night. Traditional metalized films reflect equally both inside and outside, becoming mirror-like at night. The Night Vision line reflects more to the outside, where you need it, and less to the inside, where you do not need it. Our high technology, carbon impregnated polyester layer provides outstanding heat rejection performance as well and gives the film a warm bronze appearance.

3M™ Affinity™ Window Films

3M™ Affinity™ Window Films offer exceptional 3M quality and features along with attractive pricing providing an exceptional value. Like our Night Vision films, they feature lower interior reflectivity and a warm bronze hue. They also feature a unique water-activated adhesive and come in 72" wide rolls.

3M™ Sun Control Films

These products normally have a thin adhesive for optimum clarity, and a micro layer of metal evenly coated on the film to reflect the infrared solar radiation. Their main task is to help reduce the amount of heat coming into a building through the windows. They help reduce glare, UV damage, can improve aesthetics of the building, and offer different levels of privacy depending on the product chosen.

3M™ Window Film

Product Lines continued

3M™ Plus All Season Films

Very similar to the sun control films in rejecting incoming solar radiation, but they have a unique patented construction that allows them to reflect man-made heat back into the room. Helps reduce the amount of heat loss through windows in areas that require heating systems. These products work for you 24 hours a day in cooler climates and on all sides of the building, even the sides that do not get incoming solar radiation.

3M™ Ultra Safety and Security Films

A patented micro-layer film with superior strength adhesive system. These products are designed to hold broken glass onto the film thus reducing the possibility of injury or damage caused by flying glass shards. Because of the unique tear resistant properties of our micro-layer film it also provides security and impact resistance for TERRORIST BOMBINGS, HURRICANES, SMASH & GRAB CRIMES, EARTHQUAKES, INDUSTRIAL EXPLOSIONS. Some versions of these films also provide sun control features.

3M™ Color Stable Auto Films

These products have an exciting new technology that protects the film from changing color. These products also have an adhesive system designed to hold to curved automobile glass. They also have features that allow the installers to smooth the film to the glass with fewer wrinkles, bubbles or other problems, thus providing the car owner with a high quality application. All products feature a distinctive color that compliments the automobile color and provides a sleek appearance.

3M™ Black Chrome Auto Films

3M™ Black Chrome Automotive Window Films are a premium line of metallic window films that not only enhance your vehicle's appearance, but offer excellent heat rejection, glare control, privacy, and protection from the damaging UV effects of the sun. 3M™ Black Chrome Automotive Window Films come with a limited lifetime warranty not to peel, bubble, blister, fade or discolor.

3M™ Window Film

Product Lines continued

3M™ FX Auto Films

3M now offers two additional automotive window film product lines: 3M™ FX-ST and 3M™ FX-HP Automotive Window Films. FX Standard Auto Film delivers great looks and great performance. FX High Performance Auto Film contains a metal coating that provides additional heat rejection qualities. Both product lines provide 99% UV protection, scratch resistant coating, and several different shading levels in an attractive charcoal hue. 3M™ FX-ST has a limited three year warranty and 3M™ FX-HP carries a limited lifetime warranty.

3M™ FASARA™ Interior Design Films

3M™ Fasara™ Interior Design Films will add a new dimension to your glass. Decorative films are applied to the glass creating a beautiful etched-glass appearance not typically found in window films. Light is dispersed softly, rendering a high-class, tranquil atmosphere. We have premium Interior Design films suited for interior glass partitions or inside surface of windows. Developed for the Asian market, the Fasara films offer the opportunity to immerse oneself in the aesthetic serenity distinctive to the Japanese culture, while still maintaining the outstanding quality provided by 3M technology.

3M™ SCOTCHGARD™ Anti-Graffiti Films

Graffiti artists are changing their techniques to create their “works of art.” In place of using only spray paints and markers to deface glass and other smooth surfaces, vandals are also using glass-etching solutions and tungsten carbide styluses for scratching and defacing your property. Scotchgard™ will resist these and other types of graffiti while protecting your property. Once applied the film will also provide protection from broken glass by holding the glass together.

3M™ Counter Intelligence Films

3M™ Counter Intelligence films offer the latest technology to help keep your information secure. Available in both a standard and Ultra Safety & Security version, these films offer unrivaled signal attenuation to reduce or eliminate the risk of industrial espionage. 3M™ Counter Intelligence films block RF (cell phones, WiFi, Bluetooth, etc.) signals from leaking out of the window, prevent the use of laser microphones to listen and record voice data, and prevent IR communication signals from being intercepted and analyzed for information. In addition, they provide many of the same benefits of a Sun Control film: UV, glare, fading, and solar energy reduction.

3M™ Window Film Product Identification System

Prefix	Transmission	Color	Suffix	Impact Performance
LE - Low E CS - Color Stable Auto Film BC - Black Chrome Auto Film FX - Auto Film RE - Reflective P - 18ARL SH - Shatter S - Ultra Safety and Security NV - Night Vision AG - Anti-Graffiti	Percent Visible Light Transmission OR Thickness of Safety & Security Film	AM - Amber BR - Bronze CL - Clear CU - Copper MA - Matte NE - Neutral SI - Silver SL - Slate	AR - Abrasion Resistant L - Liner X - Exterior	150 (ft. lbs.) 400 (ft. lbs.) of Impact Resistance

Example:
RE35NEARL - A reflective film that will allow approximately 35 percent of the visible light through, neutral color with an abrasion resistant coating and has a liner.

Example:
SCLARL400 - Ultra high performance safety and security film that is clear in color, has an abrasion resistant coating, and a protective liner. It passes 400 ft lb. impact resistance performance criteria

3M™ Window Film Product Families

	Super Low Transmission	Low Transmission	Medium Transmission	High Transmission
1. Automotive Films	CS-5 BC-10 FX HP-5 FX-ST-5	CS-20 BC-20 FX HP-20 FX-HP-30 FX-ST-20	CS-35 BC-35 FX HP-35 FX ST-35 FX-ST-40	CS-50 BC-40 FX HP-50 FX-ST-50

	High Performance	Medium Performance	High Transmission
2. Sun Control Films	PRESTIGE 40 PRESTIGE 50 PRESTIGE 60 PRESTIGE 70 RE35AMARL RE20NEARL P-18ARL RE15SIXL RE 20BRARXL RE 35NEARXL RE 35SIARXL RE35SIARL NV-15 LE35AMARL	RE35NEARL NV-25 NV-35 AFFINITY 15 AFFINITY 35	RE50NEARL RE70NEARL NV-45
<ul style="list-style-type: none"> • Amber • Neutral • Silver • Warm Bronze • Amber 			

3M™ Window Film Product Families Continued

	High Performance	Medium Performance	High Transmission
3. Safety & Security Films <ul style="list-style-type: none"> • Clear • Silver • Night Vision • Neutral 	SCLARL400 ULTRA600 SH7CLARL SH8CLARL SH14CLARL S20SIARL400 S25NVAR400 S35NEARL400 S50NEARL400 CI100T CI100B	SCLARL150	

3M™ Window Film

Product Performance Guidelines

Single Clear Glass

Single Tinted Glass

Double Clear Glass

Double Tinted Glass

SINGLE CLEAR GLASS

	Shading Coefficient	Visible Light Reflected	Transmitted	Emissivity	U Value	Heat Gain Reduction	Heat Loss	Glare	UV Block	Total Solar Energy Rejected
1/4" CLEAR	0.94	8%	88%	0.84	1.06	NA	NA	NA	38%	18%
PRESTIGE 40	0.47	6%	39%	0.78	0.99	50%	3%	56%	99%	59%
PRESTIGE 50	0.51	6%	50%	0.78	0.99	46%	3%	43%	99%	56%
PRESTIGE 60	0.55	8%	61%	0.78	0.99	41%	3%	31%	99%	52%
PRESTIGE 70	0.58	9%	68%	0.78	0.99	38%	3%	23%	99%	50%
NV-15	0.29	19%	15%	0.70	1.04	69%	2%	83%	99%	75%
NV-25	0.39	13%	24%	0.72	1.05	59%	1%	72%	99%	66%
NV-35	0.49	12%	35%	0.74	1.06	49%	0%	60%	99%	45%
NV-45	0.63	8%	45%	0.78	1.06	34%	0%	49%	99%	45%
P-18ARL	0.26	58%	19%	0.65	0.95	72%	10%	78%	99%	77%
RE20NEARL	0.39	17%	16%	0.84	1.06	59%	0%	82%	99%	66%
RE35NEARL	0.51	20%	37%	0.84	1.06	45%	0%	58%	99%	56%
RE50NEARL	0.66	15%	51%	0.68	1.06	30%	0%	42%	98%	43%
RE70NEARL	0.76	9%	66%	0.87	1.08	19%	0%	25%	98%	34%
RE35AMARL	0.30	55%	30%	0.68	0.95	68%	10%	66%	99%	74%
RE35SIARL	0.40	42%	33%	0.68	0.97	57%	8%	63%	98%	65%
RE50NIARL	0.49	23%	48%	0.60	0.95	48%	11%	45%	99%	57%
AFFINITY 15	0.24	25%	9%	0.79	1.00	74%	2%	90%	99%	79%
AFFINITY 35	0.50	10%	36%	0.68	0.94	47%	8%	59%	99%	57%
RE15SIARXL	0.20	63%	16%	0.84	1.06	79%	0%	83%	99%	83%
RE 20BRARXL	0.26	32%	23%	0.67	1.02	72%	0%	74%	99%	77%
RE 35NEARXL	0.42	35%	35%	0.82	1.02	55%	0%	60%	99%	63%
RE 35SIARXL	0.42	34%	36%	0.71	1.02	55%	0%	59%	99%	63%
LE35AMARL	0.29	56%	31%	0.34	0.74	69%	30%	65%	99%	75%
S20SIAR400	0.26	58%	19%	0.65	0.95	72%	10%	78%	99%	77%
S25NVAR400	0.43	28%	24%	0.72	0.82	54%	1%	72%	99%	64%
S35NEAR400	0.51	20%	37%	0.84	1.06	45%	0%	58%	99%	56%
S50NEAR400	0.66	15%	51%	0.84	1.06	30%	0%	42%	98%	43%
SCLARL150	0.92	11%	87%	0.87	1.09	2%	0%	1%	98%	NA
SCLARL400	0.91	11%	86%	0.87	1.09	3%	0%	2%	98%	NA
ULTRA600	0.90	10%	84%	0.89	1.10	6%	0%	2%	99%	NA
SH4CLARL	0.94	8%	89%	0.84	1.06	.04	0%	9%	99%	18%
SH7CLARL	0.90	9%	86%	0.87	1.09	4%	0%	2%	98%	NA
SH8CLARL	0.91	9%	87%	0.89	1.04	3%	2%	2%	99%	21%
SH14CLARL	0.90	10%	85%	0.89	1.04	4%	2%	4%	99%	22%

SINGLE CLEAR GLASS

	Shading Coefficient	Visible Light Reflected	Transmitted	Emissivity	U Value	Heat Gain Reduction	Heat Loss	Glare	UV Block	Total Solar Energy Rejected
1/4" CLEAR	0.94	8%	88%	0.84	1.06	NA	NA	NA	38%	18%
CI100T	0.47	8%	71%	0.73	0.98	52%	6%	21%	99%	59%
CI100B	0.46	11%	69%	0.73	0.98	53%	6%	23%	99%	60%
CS-5	0.48	5%	7%	0.84	NA	49%	NA	91%	99%	58%
CS-20	0.55	5%	16%	0.84	NA	41%	NA	83%	99%	52%
CS-35	0.70	6%	38%	0.84	NA	25%	NA	56%	98%	39%
CS-50	0.77	7%	51%	0.84	NA	18%	NA	42%	98%	33%
BC-10	0.34	25%	11%	0.81	1.01	64%	1%	88%	99%	70%
BC-20	0.37	21%	17%	0.81	0.95	61%	7%	81%	99%	68%
BC-35	0.50	13%	30%	0.81	0.98	47%	4%	66%	99%	57%
BC-40	0.60	10%	41%	0.81	0.95	36%	7%	54%	99%	48%
FX HP-5	0.54	5%	3%	0.84	1.04	43%	2%	97%	99%	53%
FX HP-15	0.57	6%	14%	0.77	0.99	39%	3%	84%	99%	50%
FX HP-20	0.59	5%	23%	0.84	1.02	37%	4%	74%	99%	49%
FX HP-30	0.63	6%	31%	0.84	1.04	33%	2%	65%	99%	45%
FX HP-35	0.67	7%	41%	0.84	1.04	29%	2%	54%	99%	42%
FX HP-50	0.69	8%	49%	0.84	1.04	27%	2%	45%	99%	40%
FX ST-5	0.63	5%	4%	0.84	1.02	33%	4%	95%	99%	45%
FX ST-20	0.70	5%	23%	0.84	1.04	26%	2%	74%	99%	39%
FX ST-35	0.74	5%	33%	0.84	1.04	21%	2%	63%	99%	36%
FX ST-40	0.76	5%	41%	0.88	1.04	19%	2%	54%	99%	34%
FX ST-50	0.81	6%	54%	0.88	1.04	14%	2%	39%	99%	30%

SINGLE TINTED GLASS

	Shading Coefficient	Visible Light Reflected	Transmitted	Emissivity	U Value	Heat Gain Reduction	Heat Loss	Glare	UV Block	Total Solar Energy Rejected
1/4" TINTED	0.69	5%	50%	0.84	1.06	NA	NA	NA	81%	40%
PRESTIGE 40	0.43	6%	23%	0.78	0.99	41%	3%	57%	99%	63%
PRESTIGE 50	0.46	7%	30%	0.78	0.99	37%	3%	44%	99%	60%
PRESTIGE 60	0.48	7%	36%	0.78	0.99	34%	3%	32%	99%	58%
PRESTIGE 70	0.50	8%	41%	0.78	0.99	32%	3%	23%	99%	57%
NV-15	0.33	19%	9%	0.70	1.04	52%	2%	82%	99%	71%
NV-25	0.38	13%	14%	0.72	1.05	48%	1%	72%	99%	67%
NV-35	0.44	11%	21%	0.74	1.06	40%	0%	58%	99%	62%
NV-45	0.52	7%	27%	0.74	1.06	29%	0%	45%	99%	55%
P-18ARL	0.30	20%	10%	0.65	0.95	57%	10%	80%	99%	74%
RE20NEARL	0.37	8%	9%	0.84	1.06	46%	0%	82%	99%	68%
RE35NEARL	0.45	9%	22%	0.84	1.06	35%	0%	56%	99%	61%
RE50NEARL	0.84	6%	25%	0.84	1.06	30%	0%	50%	99%	58%
RE70NEARL	0.61	6%	41%	0.87	1.08	12%	0%	18%	99%	47%
RE35AMARL	0.33	22%	18%	0.68	0.95	52%	10%	64%	99%	71%
RE35SIARL	0.38	16%	18%	0.68	0.97	45%	0%	64%	98%	67%
RE50NIARL	0.42	10%	27%	0.60	0.95	39%	11%	45%	99%	63%
AFFINITY 15	0.37	26%	8%	0.79	0.47	54%	0%	90%	99%	68%
AFFINITY 35	0.45	10%	22%	0.68	0.94	38%	8%	59%	99%	61%
RE15SIARXL	0.16	62%	8%	0.84	1.06	77%	0%	84%	99%	86%
RE 20BRARXL	0.22	32%	14%	0.67	1.02	70%	0%	74%	99%	81%
RE 35NEARXL	0.47	10%	26%	0.82	1.02	36%	0%	51%	99%	59%
RE 35SIARXL	0.34	34%	21%	0.71	1.02	53%	0%	61%	99%	70%
LE35AMARL	0.30	18%	19%	0.34	0.74	57%	30%	62%	99%	74%
S20SIAR400	0.30	20%	10%	0.65	0.95	57%	10%	80%	99%	74%
S25NVAR400	0.43	13%	15%	0.72	0.82	38%	1%	70%	99%	66%
S35NEAR400	0.45	9%	22%	0.84	0.50	35%	0%	56%	99%	61%
S50NEAR400	0.48	6%	25%	0.84	1.06	30%	0%	50%	99%	58%
SCLARL150	0.68	7%	49%	0.87	1.09	1%	0%	2%	99%	NA
SCLARL400	0.68	6%	48%	0.87	1.09	1%	0%	4%	99%	NA
ULTRA600	0.68	6%	47%	0.89	1.10	1%	0%	6%	99%	NA
SH4CLARL	0.81	6%	66%	0.88	1.06	3%	0%	11%	99%	30%
SH7CLARL	0.67	8%	49%	0.87	1.09	3%	0%	2%	99%	NA
SH8CLARL	0.72	6%	52%	0.89	1.04	1%	0%	2%	99%	37%
SH14CLARL	0.71	6%	51%	0.89	1.04	3%	0%	4%	99%	38%

SINGLE TINTED GLASS

	Shading Coefficient	Visible Light Reflected	Transmitted	Emissivity	U Value	Heat Gain Reduction	Heat Loss	Glare	UV Block	Total Solar Energy Rejected
1/4" TINTED	0.69	5%	50%	0.84	1.06	NA	NA	NA	81%	40%
CI100T	0.44	7%	53%	0.73	0.98	47%	6%	21%	99%	62%
CI100B	0.44	8%	51%	0.73	0.98	47%	6%	24%	99%	62%
CS-5	NA	NA	NA	NA	NA	NA	NA	NA	NA	NA
CS-20	0.50	4%	10%	0.84	1.06	34%	0%	80%	99%	57%
CS-35	0.59	5%	22%	0.84	1.06	22%	0%	56%	99%	49%
CS-50	0.63	5%	30%	0.84	1.06	17%	0%	41%	99%	45%
BC-10	0.36	12%	7%	0.81	1.01	51%	1%	87%	99%	69%
BC-20	0.41	15%	12%	0.81	0.78	46%	6%	81%	99%	64%
BC-35	0.45	8%	18%	0.81	0.98	38%	4%	66%	99%	61%
BC-40	0.51	6%	25%	0.81	0.95	30%	7%	50%	99%	55%
FX HP-5	0.48	5%	2%	0.84	1.04	34%	0%	96%	99%	58%
FX HP-15	0.49	6%	8%	0.77	0.99	33%	3%	85%	99%	57%
FX HP-20	0.51	5%	14%	0.84	1.02	30%	0%	74%	99%	56%
FX HP-30	0.54	5%	19%	0.84	1.04	26%	0%	64%	99%	53%
FX HP-35	0.56	5%	25%	0.84	1.04	23%	0%	53%	99%	51%
FX HP-50	0.58	6%	29%	0.84	1.04	21%	0%	45%	99%	50%
FX ST-5	0.59	5%	3%	0.84	1.02	33%	0%	96%	99%	53%
FX ST-20	0.59	5%	14%	0.84	1.04	19%	0%	74%	99%	49%
FX ST-35	0.61	5%	20%	0.84	1.04	16%	0%	62%	99%	47%
FX ST-40	0.62	5%	25%	0.88	1.04	15%	0%	53%	99%	46%
FX ST-50	0.65	5%	32%	0.88	1.04	11%	0%	40%	99%	43%

DOUBLE CLEAR GLASS

	Shading Coefficient	Visible Light Reflected	Transmitted	Emissivity	U Value	Heat Gain Reduction	Heat Loss	Glare	UV Block	Total Solar Energy Rejected
Double Clear	0.81	14%	78%	0.84	0.51	NA	NA	NA	NA	30%
PRESTIGE 40	0.59	8%	35%	0.78	0.47	27%	0%	56%	99%	49%
PRESTIGE 50	0.61	10%	44%	0.78	0.47	25%	0%	44%	99%	47%
PRESTIGE 60	0.63	11%	54%	0.78	0.47	22%	0%	32%	99%	45%
PRESTIGE 70	0.63	13%	61%	0.78	0.46	21%	2%	23%	99%	44%
NV-15	0.43	20%	14%	0.70	0.47	48%	6%	82%	99%	63%
NV-25	0.50	13%	22%	0.72	0.47	38%	6%	71%	99%	57%
NV-35	0.58	13%	31%	0.74	0.47	28%	6%	60%	99%	50%
NV-45	0.67	9%	49%	0.78	0.48	17%	6%	48%	99%	42%
P-18ARL	0.34	55%	17%	0.65	0.47	58%	6%	78%	99%	70%
RE20NEARL	0.56	21%	14%	0.84	0.50	31%	0%	82%	99%	51%
RE35NEARL	0.58	24%	33%	0.84	0.50	28%	0%	58%	99%	50%
RE50NEARL	0.65	20%	45%	0.84	0.50	20%	0%	42%	99%	43%
RE70NEARL	0.73	15%	59%	0.87	0.50	10%	0%	24%	98%	37%
RE35AMARL	0.37	53%	28%	0.68	0.47	54%	6%	64%	99%	68%
RE35SIARL	0.45	45%	30%	0.68	0.47	44%	6%	62%	98%	61%
RE50NIARL	0.54	27%	55%	0.74	0.49	23%	2%	30%	99%	46%
AFFINITY 15	0.37	26%	8%	0.79	0.47	54%	0%	90	99%	68%
AFFINITY 35	0.59	12%	32%	0.68	0.45	27%	4%	59%	99%	49%
RE15SIARXL	0.15	63%	15%	0.84	0.50	81%	0%	81%	99%	87%
RE 20BRARXL	0.19	33%	21%	0.67	0.47	77%	0%	73%	99%	83%
RE 35NEARXL	0.33	36%	32%	0.82	0.47	59%	0%	59%	99%	71%
RE 35SIARXL	0.33	35%	33%	0.71	0.47	59%	0%	58%	99%	71%
LE35AMARL	0.35	54%	29%	0.34	0.40	57%	20%	63%	99%	70%
S20SIAR400	0.34	55%	17%	0.65	0.47	58%	6%	78%	99%	70%
S25NVAR400	0.50	28%	23%	0.72	0.42	38%	5%	71%	99%	56%
S35NEAR400	0.58	24%	33%	0.84	0.50	28%	0%	58%	99%	50%
S50NEAR400	0.65	20%	45%	0.84	0.50	20%	0%	42%	99%	43%
SCLARL150	0.78	17%	77%	0.87	0.50	4%	0%	1%	99%	NA
SCLARL400	0.79	18%	75%	0.87	0.50	2%	0%	0%	99%	NA
ULTRA600	0.79	18%	73%	0.89	0.50	2%	0%	6%	99%	NA
SH4CLARL	0.84	15%	81%	0.84	0.49	3%	0	3%	99%	27%
SH7CLARL	0.79	17%	75%	0.87	0.50	2%	0%	4%	99%	NA
SH8CLARL	0.80	15%	77%	0.89	0.48	1%	0%	3%	99%	30%
SH14CLARL	0.79	16%	72%	0.89	0.48	2%	0%	9%	99%	31%

DOUBLE CLEAR GLASS

	Shading Coefficient	Visible Light Reflected	Transmitted	Emissivity	U Value	Heat Gain Reduction	Heat Loss	Glare	UV Block	Total Solar Energy Rejected
Double Clear	0.81	14%	78%	0.84	0.51	NA	NA	NA	NA	30%
CI100T	0.54	15%	64%	0.73	0.46	38%	4%	21%	99%	53%
CI100B	0.53	17%	63%	0.73	0.46	39%	4%	23%	99%	54%
CS-5	NA	NA	NA	NA	NA	NA	NA	NA	NA	NA
CS-20	0.65	13%	14%	0.84	0.50	19%	0%	82%	99%	45%
CS-35	0.71	13%	34%	0.84	0.50	11%	0%	57%	99%	38%
CS-50	0.73	14%	46%	0.84	0.50	9%	0%	42%	99%	37%
BC-10	0.50	28%	10%	0.81	0.47	39%	1%	87%	99%	57%
BC-20	0.47	21%	13%	0.81	0.45	36%	4%	81%	99%	59%
BC-35	0.60	19%	27%	0.81	0.46	26%	2%	66%	99%	48%
BC-40	0.65	16%	37%	0.81	0.45	19%	4%	53%	99%	43%
FX HP-5	0.64	12%	3%	0.84	0.48	21%	0%	96%	99%	44%
FX HP-15	0.65	7%	12%	0.77	0.46	20%	2%	85%	99%	44%
FX HP-20	0.66	13%	20%	0.84	0.47	19%	0%	75%	99%	43%
FX HP-30	0.68	13%	28%	0.84	0.48	16%	0%	65%	99%	41%
FX HP-35	0.70	14%	37%	0.84	0.48	14%	0%	53%	99%	39%
FX HP-50	0.70	15%	43%	0.84	0.48	14%	0%	46%	99%	39%
FX ST-5	0.68	12%	4%	0.84	0.47	16%	0%	95%	99%	41%
FX ST-20	0.71	12%	21%	0.84	0.48	12%	0%	73	99%	38%
FX ST-35	0.73	12%	30%	0.84	0.48	10%	0%	62%	99%	36%
FX ST-40	0.74	12%	36%	0.88	0.48	9%	0%	54%	99%	36%
FX ST-50	0.76	13%	48%	0.88	0.48	6%	0%	39%	99%	34%

DOUBLE TINTED GLASS

	Shading Coefficient	Visible Light Reflected	Transmitted	Emissivity	U Value	Heat Gain Reduction	Heat Loss	Glare	UV Block	Total Solar Energy Rejected
Double Tinted	0.55	8%	45%	0.84	0.5	NA	NA	NA	NA	52%
PRESTIGE 40	0.45	7%	21%	0.78	0.47	24%	0%	56%	99%	61%
PRESTIGE 50	0.46	9%	27%	0.78	0.47	22%	0%	43%	99%	60%
PRESTIGE 60	0.47	10%	32%	0.78	0.47	20%	0%	32%	99%	59%
PRESTIGE 70	0.48	12%	37%	0.78	0.46	19%	2%	22%	99%	58%
NV-15	0.33	20%	9%	0.70	0.47	40%	6%	80%	99%	71%
NV-25	0.37	13%	13%	0.72	0.47	32%	6%	71%	99%	67%
NV-35	0.42	13%	19%	0.74	0.47	24%	6%	59%	99%	63%
NV-45	0.48	9%	24%	0.78	0.48	13%	6%	47%	99%	58%
P-18ARL	0.28	20%	9%	0.65	0.47	49%	6%	80%	99%	76%
RE20NEARL	0.41	11%	9%	0.84	0.50	25%	0%	80%	99%	64%
RE35NEAR	0.43	10%	19%	0.84	0.50	22%	0%	58%	99%	63%
RE50NEARL	0.48	9%	28%	0.84	0.50	13%	0%	38%	99%	58%
RE70NEARL	0.52	8%	36%	0.87	0.50	5%	0%	20%	99%	55%
RE35AMARL	0.37	53%	28%	0.68	0.47	54%	6%	64%	99%	68%
RE35SIARL	0.34	18%	18%	0.68	0.47	38%	6%	60%	98%	70%
RE50NIARL	0.40	9%	24%	0.60	0.47	29%	6%	44%	99%	65%
AFFINITY 15	0.31	25%	5%	0.79	0.47	47%	0%	89%	99%	73%
AFFINITY 35	0.45	11%	19%	0.68	0.45	24%	4%	60%	99%	61%
RE15SIARXL	0.10	62%	7%	0.84	0.50	82%	0%	84%	99%	91%
RE 20BRARXL	0.15	32%	12%	0.67	0.47	75%	0%	75%	99%	87%
RE 35NEARXL	0.33	11%	23%	0.82	0.47	44%	0%	51%	99%	71%
RE 35SIARXL	0.25	34%	19%	0.71	0.47	58%	0%	60%	99%	78%
LE35AMARL	0.28	22%	17%	0.34	0.40	49%	20%	62%	99%	76%
S20SIAR400	0.28	20%	9%	0.65	0.47	49%	6%	80%	99%	76%
S25NVAR400	0.39	15%	14%	0.72	0.42	29%	5%	69%	99%	66%
S35NEAR400	0.43	10%	19%	0.84	0.50	22%	0%	58%	99%	63%
S50NEAR400	0.48	9%	28%	0.84	0.50	13%	0%	38%	99%	58%
SCLARL150	0.53	8%	47%	0.87	0.50	4%	0%	2%	99%	NA
SCLARL400	0.55	8%	42%	0.87	0.50	0%	0%	7%	99%	NA
ULTRA600	0.55	8%	41%	0.89	0.50	0%	0%	8%	99%	NA
SH4CLARL	0.70	14%	60%	0.84	0.49	2%	0%	7%	99%	39%
SH7CLARL	0.54	8%	43%	0.87	0.50	2%	0%	4%	99%	NA
SH8CLARL	0.58	9%	46%	0.89	0.48	2%	0%	3%	99%	50%
SH14CLARL	0.58	9%	46%	0.89	0.48	2%	0%	3%	99%	50%

DOUBLE TINTED GLASS

	Shading Coefficient	Visible Light Reflected	Transmitted	Emissivity	U Value	Heat Gain Reduction	Heat Loss	Glare	UV Block	Total Solar Energy Rejected
Double Tinted	0.55	8%	45%	0.84	0.5	NA	NA	NA	NA	52%
CI100T	0.46	11%	48%	0.73	0.46	36%	4%	21%	99%	60%
CI100B	0.45	12%	47%	0.73	0.46	37%	4%	22%	99%	61%
CS-5	NA	NA	NA	NA	NA	NA	NA	NA	NA	NA
CS-20	0.51	6%	8%	0.84	NA	16%	0%	82%	99%	56%
CS-35	0.54	7%	19%	0.84	NA	11%	0%	57%	99%	53%
CS-50	0.56	7%	26%	NA	NA	8%	0%	42%	99%	51%
BC-10	0.39	13%	6%	0.81	0.47	34%	1%	87%	99%	66%
BC-20	0.39	11%	9%	0.81	0.62	38%	5%	81%	99%	66%
BC-35	0.45	10%	16%	0.81	0.46	24%	2%	66%	99%	61%
BC-40	0.49	9%	22%	0.81	0.45	18%	4%	51%	99%	58%
FX HP-5	0.48	7%	2%	0.88	0.48	19%	0%	96%	99%	58%
FX HP-15	0.49	7%	7%	0.77	0.46	17%	2%	85%	99%	57%
FX HP-20	0.49	8%	12%	0.84	0.47	17%	0%	75%	99%	57%
FX HP-30	0.51	8%	17%	88%	0.48	14%	0%	64%	99%	56%
FX HP-35	0.52	8%	22%	0.88	0.48	12%	0%	54%	99%	55%
FX HP-50	0.52	8%	26%	0.88	0.48	12%	0%	45%	99%	55%
FX ST-5	0.51	7%	2%	0.84	0.47	14%	0%	96%	99%	56%
FX ST-20	0.53	7%	12%	0.88	0.48	10%	0%	75%	99%	54%
FX ST-35	0.54	7%	18%	0.88	0.48	8%	0%	62%	99%	53%
FX ST-40	0.54	7%	22%	0.88	0.48	8%	0%	54%	99%	53%
FX ST-50	0.55	8%	29%	0.88	0.48	7%	0%	39%	99%	52%

3M Window Film

Details By Product

3M All Season Window Film





LE35AMARL

Summary





Product Benefits

- Savings on heating costs.
- Stay warmer by retaining more heat in cooler months.
- Reduces air conditioning costs.
- Stay cooler by reducing excessive heat in warmer months.
- Reduces glare and eye discomfort.
- Furniture and fabrics have a longer acceptable life.
- Increase personal safety from flying glass.

Product Performance

LE35AMARL				
Solar Heat Reduction	69%	57%	57%	49%
Heat Loss Reduction	30%	30%	20%	20%
Glare Reduction	65%	62%	63%	62%
UV Blocked	99%	99%	99%	99%
Total Solar Energy Rejected	75%	74%	70%	76%

Technical Data

Glass Type	Applied Product	Shading Coefficient	Visible Light		Emissivity	“U” Value
			Reflected	Transmitted		
	None	0.94	8%	88%	0.84	1.06
	LE35AMARL	0.29	56%	31%	0.34	0.74
	None	0.69	5%	50%	0.84	1.06
	LE35AMARL	0.30	18%	19%	0.34	0.74
	None	0.81	14%	78%	0.84	0.50
	LE35AMARL	0.35	54%	29%	0.34	0.40
	None	0.55	8%	45%	0.84	0.50
	LE35AMARL	0.28	22%	17%	0.34	0.40

3M Sun Control Window Film





P-18ARL

Summary





Product Benefits

- Reduces air conditioning costs.
- Stay cooler by reducing excessive heat in warmer months.
- Reduces glare and eye discomfort.
- Furniture and fabrics have a longer acceptable life.
- Increase personal safety from flying glass.

Product Performance

P-18ARL				
Solar Heat Reduction	72%	57%	58%	49%
Heat Loss Reduction	10%	10%	6%	6%
Glare Reduction	78%	80%	78%	80%
UV Blocked	99%	99%	99%	99%
Total Solar Energy Rejected	77%	74%	70%	76%

Technical Data

Glass Type	Applied Product	Shading Coefficient	Visible Light		Emissivity	“U” Value
			Reflected	Transmitted		
	None	0.94	8%	88%	0.84	1.06
	P-18ARL	0.26	58%	19%	0.65	0.95
	None	0.69	5%	50%	0.84	1.06
	P-18ARL	0.30	20%	10%	0.65	0.95
	None	0.81	14%	78%	0.84	0.50
	P-18ARL	0.34	55%	17%	0.65	0.47
	None	0.55	8%	45%	0.84	0.50
	P-18ARL	0.28	20%	9%	0.65	0.47

3M Sun Control Window Film





RE15SIARXL

Summary





Product Benefits

- Reduces air conditioning costs.
- Stay cooler by reducing excessive heat in warmer months.
- Improves driving comfort by reducing excessive solar heat.
- Reduces glare and eye discomfort.
- Reduces fading of fabrics interiors.
- Increased personal safety from flying glass.

Product Performance

RE15SIARXL				
Solar Heat Reduction	77%	74%	79%	78%
Heat Loss Reduction	0%	0%	0%	0%
Glare Reduction	81%	81%	81%	81%
UV Blocked	99%	99%	99%	99%
Total Solar Energy Rejected	81%	83%	85%	89%

Technical Data

Glass Type	Applied Product	Shading Coefficient	Visible Light		Visible Light Transmitted	Emissivity	“U” Value
			Exterior Reflection	Interior Reflection			
	None	0.94	8%	8%	88%	0.84	1.02
	RE15SIARXL	0.22	61%	56%	17%	0.84	1.02
	None	0.69	5%	5%	50%	0.84	1.02
	RE15SIARXL	0.19	61%	23%	10%	0.84	1.02
	None	0.81	14%	14%	78%	0.84	0.47
	RE15SIARXL	0.17	61%	55%	15%	0.84	0.47
	None	0.55	8%	8%	45%	0.84	0.47
	RE15SIARXL	0.13	61%	27%	9%	0.84	0.47

3M Sun Control Window Film





RE20BRARXL

Summary





Product Benefits

- Savings on heating costs.
- Reduces air conditioning costs.
- Stay cooler by reducing excessive heat in warmer months.
- Reduces glare and eye discomfort.
- Furniture and fabrics have a longer acceptable life.
- Increase personal safety from flying glass.

Product Performance

RE20BRARXL				
Solar Heat Reduction	72%	70%	77%	75%
Heat Loss Reduction	0%	0%	0%	0%
Glare Reduction	74%	74%	73%	75%
UV Blocked	99%	99%	99%	99%
Total Solar Energy Rejected	77%	81%	83%	87%

Technical Data

Glass Type	Applied Product	Shading Coefficient	Visible Light		Emissivity	“U” Value
			Reflected	Transmitted		
	None	0.94	8%	88%	0.84	1.06
	RE20BRARXL	0.26	32%	33%	0.67	1.02
	None	0.69	5%	50%	0.84	1.06
	RE20BRARXL	0.22	32%	15%	0.67	1.02
	None	0.81	14%	78%	0.84	0.50
	RE20BRARXL	0.19	33%	35%	0.67	0.47
	None	0.55	8%	45%	0.84	0.50
	RE20BRARXL	0.15	32%	20%	0.67	0.47

3M Sun Control Window Film





RE35NEARXL

Summary





Product Benefits

- Savings on heating costs.
- Reduces air conditioning costs.
- Stay cooler by reducing excessive heat in warmer months.
- Reduces glare and eye discomfort.
- Furniture and fabrics have a longer acceptable life.
- Increase personal safety from flying glass.

Product Performance

RE35NEARXL				
Solar Heat Reduction	55%	36%	59%	44%
Heat Loss Reduction	0%	0%	0%	0%
Glare Reduction	60%	51%	59%	51%
UV Blocked	99%	99%	99%	99%
Total Solar Energy Rejected	63%	59%	71%	71%

Technical Data

Glass Type	Applied Product	Shading Coefficient	Visible Light		Emissivity	"U" Value
			Reflected	Transmitted		
	None	0.94	8%	88%	0.84	1.06
	RE35NEARXL	0.42	13%	36%	0.82	1.01
	None	0.69	5%	50%	0.84	1.06
	RE35NEARXL	0.47	10%	8%	0.82	1.02
	None	0.81	14%	78%	0.84	0.50
	RE35NEARXL	0.33	36%	37%	0.82	0.47
	None	0.55	8%	45%	0.84	0.50
	RE35NEARXL	0.33	11%	15%	0.82	0.47

3M Sun Control Window Film





RE35SIARXL

Summary





Product Benefits

- Savings on heating costs.
- Reduces air conditioning costs.
- Reduces glare and eye discomfort.
- Furniture and fabrics have a longer acceptable life.
- Increase personal safety from flying glass.

Product Performance

RE35SIARXL				
Solar Heat Reduction	55%	53%	59%	58%
Heat Loss Reduction	0%	0%	0%	0%
Glare Reduction	59%	61%	58%	60%
UV Blocked	99%	99%	99%	99%
Total Solar Energy Rejected	63%	70%	71%	78%

Technical Data

Glass Type	Applied Product	Shading Coefficient	Visible Light		Emissivity	“U” Value
			Reflected	Transmitted		
	None	0.94	8%	88%	0.84	1.06
	RE35SIARXL	0.22	61%	56%	0.71	1.02
	None	0.69	5%	50%	0.84	1.06
	RE35SIARXL	0.19	61%	23%	0.71	1.02
	None	0.81	14%	78%	0.84	0.50
	RE35SIARXL	0.17	61%	55%	0.71	0.47
	None	0.55	8%	45%	0.84	0.50
	RE35SIARXL	0.13	61%	27%	0.71	0.47





3M Sun Control Window Film

Prestige 40 Summary





Product Benefits

- Savings on heating costs.
- Reduces air conditioning costs.
- Stay cooler by reducing excessive heat in warmer months.
- Reduces glare and eye discomfort.
- Furniture and fabrics have a longer acceptable life.
- Increased personal safety from flying glass.

Product Performance

Prestige 40				
Solar Heat Reduction	50%	41%	27%	24%
Heat Loss Reduction	3%	3%	0%	0%
Glare Reduction	56%	57%	58%	56%
UV Blocked	99%	99%	99%	99%
Total Solar Energy Rejected	59%	63%	49%	61%

Technical Data

Glass Type	Applied Product	Shading Coefficient	Visible Light		Emissivity	“U” Value
			Reflected	Transmitted		
	None	0.94	8%	88%	0.84	1.06
	Prestige 40	0.47	6%	39%	0.78	0.99
	None	0.69	5%	50%	0.84	1.06
	Prestige 40	0.43	6%	23%	0.78	0.99
	None	0.64	14%	78%	0.84	0.50
	Prestige 40	0.59	6%	35%	0.78	0.47
	None	0.55	8%	45%	0.84	0.50
	Prestige 40	0.45	7%	21%	0.78	0.47





3M Sun Control Window Film

Prestige 50 Summary





Product Benefits

- Savings on heating costs.
- Reduces air conditioning costs.
- Stay cooler by reducing excessive heat in warmer months.
- Reduces glare and eye discomfort.
- Furniture and fabrics have a longer acceptable life.
- Increased personal safety from flying glass.

Product Performance

Prestige 50				
Solar Heat Reduction	45%	37%	25%	22%
Heat Loss Reduction	3%	3%	0%	0%
Glare Reduction	43%	44%	44%	43%
UV Blocked	99%	99%	99%	99%
Total Solar Energy Rejected	58%	60%	47%	60%

Technical Data

Glass Type	Applied Product	Shading Coefficient	Visible Light		Emissivity	“U” Value
			Reflected	Transmitted		
	None	0.94	8%	88%	0.84	1.06
	Prestige 50	0.51	8%	50%	0.78	0.93
	None	0.69	5%	50%	0.84	1.06
	Prestige 50	0.46	7%	30%	0.78	0.99
	None	0.64	14%	78%	0.84	0.50
	Prestige 50	0.61	10%	44%	0.78	0.47
	None	0.55	8%	45%	0.84	0.50
	Prestige 50	0.46	9%	27%	0.78	0.47





3M Sun Control Window Film

Prestige 60 Summary





Product Benefits

- Savings on heating costs.
- Reduces air conditioning costs.
- Stay cooler by reducing excessive heat in warmer months.
- Reduces glare and eye discomfort.
- Furniture and fabrics have a longer acceptable life.
- Increased personal safety from flying glass.

Product Performance

Prestige 60				
Solar Heat Reduction	41%	34%	22%	20%
Heat Loss Reduction	3%	3%	0%	0%
Glare Reduction	31%	32%	32%	32%
UV Blocked	99%	99%	99%	99%
Total Solar Energy Rejected	52%	58%	45%	59%

Technical Data

Glass Type	Applied Product	Shading Coefficient	Visible Light		Emissivity	"U" Value
			Reflected	Transmitted		
	None	0.94	8%	88%	0.84	1.06
	Prestige 60	0.55	8%	61%	0.78	0.99
	None	0.69	5%	50%	0.84	1.06
	Prestige 60	0.48	7%	36%	0.78	0.99
	None	0.64	14%	78%	0.84	0.50
	Prestige 60	0.63	11%	54%	0.78	0.47
	None	0.55	8%	45%	0.84	0.50
	Prestige 60	0.47	10%	32%	0.78	0.47





3M Sun Control Window Film

Prestige 70 Summary





Product Benefits

- Savings on heating costs.
- Reduces air conditioning costs.
- Stay cooler by reducing excessive heat in warmer months.
- Reduces glare and eye discomfort.
- Furniture and fabrics have a longer acceptable life.
- Increased personal safety from flying glass.

Product Performance

Prestige 70				
Solar Heat Reduction	38%	32%	21%	19%
Heat Loss Reduction	3%	3%	2%	2%
Glare Reduction	23%	23%	23%	22%
UV Blocked	99%	99%	99%	99%
Total Solar Energy Rejected	50%	57%	44%	58%

Technical Data

Glass Type	Applied Product	Shading Coefficient	Visible Light		Emissivity	“U” Value
			Reflected	Transmitted		
	None	0.94	8%	88%	0.84	1.06
	Prestige 70	0.58	9%	68%	0.78	0.99
	None	0.69	5%	50%	0.84	1.06
	Prestige 70	0.50	8%	41%	0.78	0.99
	None	0.81	14%	78%	0.84	0.50
	Prestige 70	0.64	13%	61%	0.78	0.46
	None	0.55	8%	45%	0.84	0.50
	Prestige 70	0.48	12%	37%	0.78	0.46

3M Sun Control Window Film - Night Vision Series





NV-15

Summary





Product Benefits

- New warm tones complement and defend against solar rays.
- A warm natural hue invites warmth and beauty to any room.
- Low interior and exterior reflectivity, especially at night!
- Great heat rejection for dual pane windows.
- New 3M technology enhances color stability.
- Reduce air conditioning costs and stay cooler by reducing excessive solar heat especially in hot sunny climates.
- Extend the life and vibrancy in the fabric of furniture and carpets.
- Increases personal safety from flying or broken glass.

Product Performance

NV-15				
Solar Heat Reduction	69%	52%	48%	40%
Heat Loss Reduction	2%	2%	6%	6%
Glare Reduction	83%	82%	82%	80%
UV Blocked	99%	99%	99%	99%
Total Solar Energy Rejected	75%	71%	63%	71%

Technical Data

Glass Type	Applied Product	Shading Coefficient	Visible Light		Visible Light Transmitted	Emissivity	“U” Value
			Exterior Reflection	Interior Reflection			
	None	0.94	8%	8%	88%	0.84	1.06
	NV-15	0.29	43%	19%	15%	0.70	1.04
	None	0.69	5%	5%	50%	0.84	1.06
	NV-15	0.38	16%	19%	9%	0.70	1.04
	None	0.81	14%	14%	78%	0.84	0.50
	NV-15	0.42	44%	20%	14%	0.70	0.47
	None	0.55	8%	8%	45%	0.84	0.50
	NV-15	0.33	20%	20%	9%	0.70	0.47

3M Sun Control Window Film - Night Vision Series





NV-25

Summary





Product Benefits

- New warm tones complement and defend against solar rays.
- A warm natural hue invites warmth and beauty to any room.
- Low interior and exterior reflectivity, especially at night!
- Great heat rejection for dual pane windows.
- New 3M technology enhances color stability.
- Reduce air conditioning costs and stay cooler by reducing excessive solar heat especially in hot sunny climates.
- Extend the life and vibrancy in the fabric of furniture and carpets.
- Increases personal safety from flying or broken glass.

Product Performance

NV-25				
Solar Heat Reduction	59%	48%	38%	32%
Heat Loss Reduction	1%	1%	6%	6%
Glare Reduction	72%	72%	71%	71%
UV Blocked	99%	99%	99%	99%
Total Solar Energy Rejected	66%	67%	57%	67%

Technical Data

Glass Type	Applied Product	Shading Coefficient	Visible Light		Visible Light Transmitted	Emissivity	“U” Value
			Exterior Reflection	Interior Reflection			
	None	0.94	8%	8%	88%	0.84	1.06
	NV-25	0.39	29%	13%	24%	0.72	1.05
	None	0.69	5%	5%	50%	0.84	1.06
	NV-25	0.33	12%	13%	14%	0.72	1.05
	None	0.81	14%	14%	78%	0.84	0.50
	NV-25	0.50	32%	13%	22%	0.72	0.47
	None	0.55	8%	8%	45%	0.84	0.50
	NV-25	0.37	15%	13%	13%	0.72	0.47

3M Sun Control Window Film - Night Vision Series





NV-35

Summary





Product Benefits

- New warm tones complement and defend against solar rays.
- A warm natural hue invites warmth and beauty to any room.
- Low interior and exterior reflectivity, especially at night!
- Great heat rejection for dual pane windows.
- New 3M technology enhances color stability.
- Reduce air conditioning costs and stay cooler by reducing excessive solar heat especially in hot sunny climates.
- Extend the life and vibrancy in the fabric of furniture and carpets.
- Increases personal safety from flying or broken glass.

Product Performance

NV-35				
Solar Heat Reduction	49%	40%	28%	24%
Heat Loss Reduction	0%	0%	6%	6%
Glare Reduction	60%	58%	60%	59%
UV Blocked	99%	99%	99%	99%
Total Solar Energy Rejected	57%	62%	50%	63%

Technical Data

Glass Type	Applied Product	Shading Coefficient	Visible Light		Visible Light Transmitted	Emissivity	“U” Value
			Exterior Reflection	Interior Reflection			
	None	0.94	8%	8%	88%	0.84	1.06
	NV-35	0.49	18%	12%	35%	0.74	1.06
	None	0.69	5%	5%	55%	0.84	1.06
	NV-35	0.44	8%	11%	21%	0.74	1.06
	None	0.81	14%	14%	78%	0.84	0.50
	NV-35	0.58	23%	13%	31%	0.74	0.47
	None	0.55	8%	8%	45%	0.84	0.50
	NV-35	0.42	11%	13%	19%	0.74	0.47

3M Sun Control Window Film - Night Vision Series





NV-45

Summary





Product Benefits

- New warm tones complement and defend against solar rays.
- A warm natural hue invites warmth and beauty to any room.
- Low interior and exterior reflectivity, especially at night!
- Great heat rejection for dual pane windows.
- New 3M technology enhances color stability.
- Reduce air conditioning costs and stay cooler by reducing excessive solar heat especially in hot sunny climates.
- Extend the life and vibrancy in the fabric of furniture and carpets.
- Increases personal safety from flying or broken glass.

Product Performance

NV-45				
Solar Heat Reduction	34%	29%	17%	13%
Heat Loss Reduction	0%	0%	6%	6%
Glare Reduction	49%	45%	48%	47%
UV Blocked	99%	99%	99%	99%
Total Solar Energy Rejected	45%	55%	42%	58%

Technical Data

Glass Type	Applied Product	Shading Coefficient	Visible Light Reflection		Visible Light Transmitted	Emissivity	“U” Value
			Exterior	Interior			
	None	0.94	8%	8%	88%	0.84	1.06
	NV-45	0.63	9.4%	8%	45%	0.78	1.06
	None	0.69	5%	5%	50%	0.84	1.06
	NV-45	0.52	6.4%	7%	27%	0.78	1.06
	None	0.81	14%	14%	78%	0.84	0.50
	NV-45	0.67	16.1%	9%	40%	0.78	0.48
	None	0.55	8%	8%	45%	0.84	0.50
	NV-45	0.48	9%	9%	24%	0.78	0.48

3M Sun Control Window Film





RE50NIARL

Summary





Product Benefits

- Stay cooler by reducing excessive heat in warmer months.
- Extends the life of furniture and fabrics.
- Maintains more natural appearance.
- Reduces glare and eye discomfort.
- Increase personal safety from flying glass.

Product Performance

RE50NIARL				
Solar Heat Reduction	48%	39%	33%	29%
Heat Loss Reduction	11%	11%	6%	6%
Glare Reduction	45%	45%	46%	44%
UV Blocked	99%	99%	99%	99%
Total Solar Energy Rejected	57%	63%	53%	65%

Technical Data

Glass Type	Applied Product	Shading Coefficient	Visible Light		Emissivity	“U” Value
			Reflected	Transmitted		
	None	0.94	9%	88%	0.84	1.06
	RE50NIARL	0.49	23%	48%	0.60	0.95
	None	0.69	4%	49%	0.84	1.06
	RE50NIARL	0.42	10%	27%	0.60	0.95
	None	0.81	15%	79%	0.84	0.50
	RE50NIARL	0.54	27%	43%	0.60	0.47
	None	0.55	6%	43%	0.84	0.50
	RE50NIARL	0.40	9%	24%	0.60	0.47

3M Sun Control Window Film





RE20NEARL

Summary





Product Benefits

- Reduces air conditioning costs.
- Stay cooler by reducing excessive heat in warmer months.
- Reduces glare and eye discomfort.
- Furniture and fabrics have a longer acceptable life.
- Increase personal safety from flying glass.

Product Performance

RE20NEARL				
Solar Heat Reduction	59%	46%	31%	25%
Heat Loss Reduction	0%	0%	0%	0%
Glare Reduction	82%	82%	82%	80%
UV Blocked	99%	99%	99%	99%
Total Solar Energy Rejected	66%	68%	51%	64%

Technical Data

Glass Type	Applied Product	Shading Coefficient	Visible Light		Emissivity	“U” Value
			Reflected	Transmitted		
	None	0.94	8%	88%	0.84	1.06
	RE20NEARL	0.39	17%	16%	0.84	1.06
	None	0.69	5%	50%	0.84	1.06
	RE20NEARL	0.37	8%	9%	0.84	1.06
	None	0.81	14%	78%	0.84	0.50
	RE20NEARL	0.56	21%	14%	0.84	0.50
	None	0.55	8%	45%	0.84	0.50
	RE20NEARL	0.41	11%	9%	0.84	0.50

3M Sun Control Window Film





RE35NEARL

Summary





Product Benefits

- Reduces air conditioning costs.
- Stay cooler by reducing excessive heat in warmer months.
- Reduces glare and eye discomfort.
- Furniture and fabrics have a longer acceptable life.
- Increase personal safety from flying glass.

Product Performance

RE35NEARL				
Solar Heat Reduction	45%	35%	28%	22%
Heat Loss Reduction	0%	0%	0%	0%
Glare Reduction	58%	56%	58%	58%
UV Blocked	99%	99%	99%	99%
Total Solar Energy Rejected	56%	61%	50%	63%

Technical Data

Glass Type	Applied Product	Shading Coefficient	Visible Light		Emissivity	“U” Value
			Reflected	Transmitted		
	None	0.94	8%	88%	0.84	1.06
	RE35NEARL	0.51	20%	37%	0.84	1.06
	None	0.69	5%	50%	0.84	1.06
	RE35NEARL	0.45	9%	22%	0.84	1.06
	None	0.81	14%	78%	0.84	0.50
	RE35NEARL	0.58	24%	33%	0.84	0.50
	None	0.55	8%	45%	0.84	0.50
	RE35NEARL	0.43	10%	19%	0.84	0.50

3M Sun Control Window Film





RE50NEARL

Summary





Product Benefits

- Reduces air conditioning costs.
- Stay cooler by reducing excessive heat in warmer months.
- Reduces glare and eye discomfort.
- Furniture and fabrics have a longer acceptable life.
- Increase personal safety from flying glass.

Product Performance

RE50NEARL				
Solar Heat Reduction	30%	30%	20%	13%
Heat Loss Reduction	0%	0%	0%	0%
Glare Reduction	42%	50%	42%	38%
UV Blocked	98%	99%	99%	99%
Total Solar Energy Rejected	43%	58%	43%	58%

Technical Data

Glass Type	Applied Product	Shading Coefficient	Visible Light		Emissivity	“U” Value
			Reflected	Transmitted		
	None	0.94	8%	88%	0.84	1.06
	RE50NEARL	0.66	15%	51%	0.84	1.06
	None	0.69	5%	50%	0.84	1.06
	RE50NEARL	0.48	6%	25%	0.84	1.06
	None	0.81	14%	78%	0.84	0.50
	RE50NEARL	0.65	20%	45%	0.84	0.50
	None	0.55	8%	45%	0.84	0.50
	RE50NEARL	0.48	9%	28%	0.84	0.50

3M Sun Control Window Film





RE70NEARL

Summary





Product Benefits

- Reduces air conditioning costs.
- Stay cooler by reducing excessive heat in warmer months.
- Reduces glare and eye discomfort.
- Furniture and fabrics have a longer acceptable life.
- Increase personal safety from flying glass.

Product Performance

RE70NEARL				
Solar Heat Reduction	19%	12%	10%	5%
Heat Loss Reduction	0%	0%	0%	0%
Glare Reduction	25%	18%	24%	20%
UV Blocked	98%	99%	98%	99%
Total Solar Energy Rejected	34%	47%	37%	55%

Technical Data

Glass Type	Applied Product	Shading Coefficient	Visible Light		Emissivity	“U” Value
			Reflected	Transmitted		
	None	0.94	8%	88%	0.84	1.06
	RE70NEARL	0.68	8%	66%	0.84	1.06
	None	0.69	5%	50%	0.84	1.06
	RE70NEARL	0.52	6%	26%	0.84	1.06
	None	0.81	14%	78%	0.84	0.50
	RE70NEARL	0.70	14%	41%	0.84	0.50
	None	0.55	8%	45%	0.84	0.50
	RE70NEARL	0.50	8%	25%	0.84	0.50

3M Sun Control Window Film





RE35AMARL

Summary





Product Benefits

- Reduces air conditioning costs.
- Stay cooler by reducing excessive heat in warmer months.
- Reduces glare and eye discomfort.
- Furniture and fabrics have a longer acceptable life.
- Increase personal safety from flying glass.

Product Performance

RE35AMARL				
Solar Heat Reduction	68%	52%	54%	45%
Heat Loss Reduction	10%	10%	6%	6%
Glare Reduction	66%	64%	64%	62%
UV Blocked	99%	99%	99%	99%
Total Solar Energy Rejected	74%	71%	68%	74%

Technical Data

Glass Type	Applied Product	Shading Coefficient	Visible Light		Emissivity	“U” Value
			Reflected	Transmitted		
	None	0.94	8%	88%	0.84	1.06
	RE35AMARL	0.30	55%	30%	0.68	0.95
	None	0.69	5%	50%	0.84	1.06
	RE35AMARL	0.33	22%	18%	0.68	0.95
	None	0.81	14%	78%	0.84	0.50
	RE35AMARL	0.37	53%	28%	0.68	0.47
	None	0.55	8%	45%	0.84	0.50
	RE35AMARL	0.30	22%	17%	0.68	0.47

3M Sun Control Window Film





RE35SIARL

Summary





Product Benefits

- Reduces air conditioning costs.
- Stay cooler by reducing excessive heat in warmer months.
- Reduces glare and eye discomfort.
- Furniture and fabrics have a longer acceptable life.
- Increase personal safety from flying glass.

Product Performance

RE35SIARL				
Solar Heat Reduction	57%	45%	44%	38%
Heat Loss Reduction	8%	8%	6%	6%
Glare Reduction	63%	64%	62%	60%
UV Blocked	98%	98%	98%	98%
Total Solar Energy Rejected	65%	67%	61%	70%

Technical Data

Glass Type	Applied Product	Shading Coefficient	Visible Light		Emissivity	“U” Value
			Reflected	Transmitted		
	None	0.94	8%	88%	0.84	1.06
	RE35SIARL	0.40	42%	33%	0.68	0.97
	None	0.69	5%	50%	0.84	1.06
	RE35SIARL	0.38	16%	18%	0.68	0.97
	None	0.81	14%	78%	0.84	0.50
	RE35SIARL	0.45	42%	30%	0.68	0.47
	None	0.55	8%	45%	0.84	0.50
	RE35SIARL	0.34	18%	18%	0.68	0.47

3M Sun Control Window Film





Affinity 15

Summary





Product Benefits

- Savings on heating costs.
- Stay warmer by retaining more heat in cooler months.
- Reduces air conditioning costs.
- Stay cooler by reducing excessive heat in warmer months.
- Reduces glare and eye discomfort.
- Furniture and fabrics have a longer acceptable life.
- Increased personal safety from flying glass.

Product Performance

Affinity15				
Solar Heat Reduction	74%	58%	54%	47%
Heat Loss Reduction	2%	2%	0%	0%
Glare Reduction	90%	91%	90%	89%
UV Blocked	99%	99%	99%	99%
Total Solar Energy Rejected	79%	73%	68%	73%

Technical Data

Glass Type	Applied Product	Shading Coefficient	Visible Light		Emissivity	"U" Value
			Reflected	Transmitted		
	None	0.94	8%	88%	0.84	1.06
	Affinity 15	0.24	25%	9%	0.79	1.00
	None	0.69	5%	50%	0.84	1.06
	Affinity 15	0.31	25%	5%	0.79	1.00
	None	0.81	14%	78%	0.50	0.50
	Affinity 15	0.37	26%	8%	0.79	0.47
	None	0.55	8%	46%	0.50	0.50
	Affinity 15	0.31	25%	5%	0.79	0.47

3M Sun Control Window Film





Affinity 30

Summary





Product Benefits

- Savings on heating costs.
- Stay warmer by retaining more heat in cooler months.
- Reduces air conditioning costs.
- Stay cooler by reducing excessive heat in warmer months.
- Reduces glare and eye discomfort.
- Furniture and fabrics have a longer acceptable life.
- Increased personal safety from flying glass.

Product Performance

Affinity 30				
Solar Heat Reduction	48%	44%	29%	27%
Heat Loss Reduction	9%	9%	4%	4%
Glare Reduction	60%	60%	59%	59%
UV Blocked	99%	99%	99%	99%
Total Solar Energy Rejected	56%	59%	46%	55%

Technical Data

Glass Type	Applied Product	Shading Coefficient	Visible Light		Emissivity	“U” Value
			Reflected	Transmitted		
	None	0.94	8%	88%	0.84	1.06
	Affinity 30	0.51	10%	36%	0.68	0.95
	None	0.69	5%	50%	0.84	1.06
	Affinity 30	0.47	10%	27%	0.68	0.95
	None	0.81	14%	78%	0.84	0.50
	Affinity 30	0.62	12%	33%	0.68	0.46
	None	0.55	8%	45%	0.84	0.50
	Affinity 30	0.52	11%	25%	0.68	0.46

3M Ultra Safety & Security Window Film





SCLARL150

Summary





Product Benefits

- Reduces fading from UV light. furniture and fabrics have a longer acceptable life.
- Increase personal safety from flying glass.
- Deters smash and grab burglaries.

Product Performance

SCLARL150				
Solar Heat Reduction	2%	1%	4%	4%
Heat Loss Reduction	0%	0%	0%	0%
Glare Reduction	1%	2%	1%	2%
UV Blocked	98%	99%	99%	99%

Technical Data

Glass Type	Applied Product	Shading Coefficient	Visible Light		Emissivity	“U” Value
			Reflected	Transmitted		
	None	0.94	8%	88%	0.84	1.06
	SCLARL150	0.92	11%	87%	0.87	1.06
	None	0.69	5%	50%	0.84	1.06
	SCLARL150	0.68	7%	49%	0.87	1.06
	None	0.81	14%	78%	0.84	0.50
	SCLARL150	0.78	17%	77%	0.87	0.50
	None	0.55	8%	45%	0.84	0.50
	SCLARL150	0.53	8%	47%	0.87	0.50

3M Ultra Safety & Security Window Film





SCLARL400

Summary





Product Benefits

- Reduces fading from UV light. furniture and fabrics have a longer acceptable life.
- Increase personal safety from flying glass.
- Deters smash and grab burglaries.

Product Performance

SCLARL400				
Solar Heat Reduction	3%	1%	2%	0%
Heat Loss Reduction	0%	0%	0%	0%
Glare Reduction	2%	4%	0%	7%
UV Blocked	98%	99%	99%	99%

Technical Data

Glass Type	Applied Product	Shading Coefficient	Visible Light		Emissivity	“U” Value
			Reflected	Transmitted		
	None	0.94	8%	88%	0.84	1.06
	SCLARL400	0.91	11%	86%	0.87	1.09
	None	0.69	5%	50%	0.84	1.06
	SCLARL400	0.68	6%	48%	0.87	1.09
	None	0.81	14%	78%	0.84	0.50
	SCLARL400	0.79	18%	75%	0.87	0.50
	None	0.55	8%	45%	0.84	0.50
	SCLARL400	0.55	8%	42%	0.87	0.50

3M Ultra Safety & Security Window Film





ULTRA600

Summary





Product Benefits

- Savings on heating costs.
- Deters smash and grab burglaries.
- Increase protection from windstorms, blasts, and earthquakes.
- Reduces fading of furniture and fabrics.

Product Performance

ULTRA600				
Solar Heat Reduction	6%	1%	2%	0%
Heat Loss Reduction	0%	0%	0%	0%
Glare Reduction	2%	6%	6%	8%
UV Blocked	99%	99%	99%	99%

Technical Data

Glass Type	Applied Product	Shading Coefficient	Visible Light		Emissivity	“U” Value
			Reflected	Transmitted		
	None	0.94	8%	88%	0.84	1.06
	ULTRA600	0.90	10%	84%	0.89	1.10
	None	0.69	5%	50%	0.84	1.06
	ULTRA600	0.68	6%	47%	0.89	1.10
	None	0.81	14%	78%	0.84	0.50
	ULTRA600	0.79	18%	73%	0.89	0.50
	None	0.55	8%	45%	0.84	0.50
	ULTRA600	0.55	8%	41%	0.89	0.50

3M Ultra Prestige Series Safety and Security Films





Ultra Prestige Series PR S50

Summary

Product Benefits

- Savings on heating costs.
- Reduces air conditioning costs.
- Stay cooler by reducing excessive heat in warmer months.
- Reduces glare and eye discomfort-
- Furniture and fabrics have a longer acceptable life.
- Increases personal safety from flying or broken glass.
- Increases protection from windstorms, blasts and earthquakes.
- Deter smash and grab burglaries.
- Low interior and exterior reflectivity, especially at night!

Product Performance

ULTRA Prestige PR S50				
Solar Heat Reduction	46%	37%	25%	22%
Heat Loss Reduction	3%	3%	2%	2%
Glare Reduction	45%	45%	44%	45%
UV Blocked	99%	99%	99%	99%
Total Solar Energy Rejected	56%	60%	47%	60%

Technical Data

Glass Type	Applied Product	Shading Coefficient	Visible Light		Emissivity	"U" Value
			Reflected	Transmitted		
	None	0.94	8%	88%	0.84	1.06
	ULTRA PR S50	0.51	8%	49%	0.77	0.99
	None	0.69	5%	50%	0.84	1.06
	ULTRA PR S50	0.46	7%	29%	0.77	0.99
	None	0.81	14%	78%	0.84	0.50
	ULTRA PR S50	0.61	10%	44%	0.77	0.46
	None	0.55	8%	45%	0.84	0.50
	ULTRA PR S50	0.46	9%	26%	0.77	0.46

3M Ultra Prestige Series Safety and Security Films





Ultra Prestige Series PR S70

Summary

Product Benefits

- Savings on heating costs.
- Reduces air conditioning costs.
- Stay cooler by reducing excessive heat in warmer months.
- Reduces glare and eye discomfort-
- Furniture and fabrics have a longer acceptable life.
- Increases personal safety from flying or broken glass.
- Increases protection from windstorms, blasts and earthquakes.
- Deter smash and grab burglaries.
- Low interior and exterior reflectivity, especially at night!

Product Performance

ULTRA Prestige PR S70				
Solar Heat Reduction	39%	32%	22%	19%
Heat Loss Reduction	3%	3%	2%	2%
Glare Reduction	25%	25%	25%	24%
UV Blocked	99%	99%	99%	99%
Total Solar Energy Rejected	50%	57%	45%	58%

Technical Data

Glass Type	Applied Product	Shading Coefficient	Visible Light		Emissivity	"U" Value
			Reflected	Transmitted		
	None	0.94	8%	88%	0.84	1.06
	ULTRA PR S70	0.57	9%	66%	0.77	0.99
	None	0.69	5%	50%	0.84	1.06
	ULTRA PR S70	0.50	8%	40%	0.77	0.99
	None	0.81	14%	78%	0.84	0.50
	ULTRA PR S70	0.63	13%	59%	0.77	0.46
	None	0.55	8%	45%	0.84	0.50
	ULTRA PR S70	0.48	12%	36%	0.77	0.46

3M Ultra Safety & Security Window Film





S20SIAR400

Summary





Product Benefits

- Increase personal safety from flying glass.
- Deters smash and grab burglaries.
- Increase protection from windstorms, blasts, and earthquakes.
- Increase daytime privacy.
- Reduces air conditioning costs.
- Stay cooler by reducing excessive heat in warmer months.
- Reduces glare and eye discomfort.
- Furniture and fabrics have a longer acceptable life.

Product Performance

S20SIAR400				
Solar Heat Reduction	72%	57%	58%	49%
Heat Loss Reduction	10%	10%	6%	6%
Glare Reduction	78%	80%	78%	80%
UV Blocked	99%	99%	99%	99%
Total Solar Energy Rejected	77%	74%	70%	76%

Technical Data

Glass Type	Applied Product	Shading Coefficient	Visible Light		Emissivity	“U” Value
			Reflected	Transmitted		
	None	0.94	8%	88%	0.84	1.06
	S20SIAR400	0.26	58%	19%	0.65	0.95
	None	0.69	5%	50%	0.84	1.06
	S20SIAR400	0.30	20%	10%	0.65	0.95
	None	0.81	14%	78%	0.84	0.50
	S20SIAR400	0.34	55%	17%	0.65	0.47
	None	0.55	8%	45%	0.84	0.50
	S20SIAR400	0.28	20%	9%	0.65	0.47

3M Ultra Night Vision Safety & Security Window Film





S25NVAR400

Summary





Product Benefits

- Increases personal safety from flying or broken glass.
- Increases protection from windstorms, blasts and earthquakes.
- Deter smash and grab burglaries.
- A warm, natural hue invites warmth and beauty to any room.
- Low interior and exterior reflectivity, especially at night!
- Great heat rejection for dual pane windows.
- Reduce air conditioning costs and stay cooler by reducing excessive solar heat.
- Extend the life and vibrancy in the fabric of furniture and carpets

Product Performance

S25NVAR400				
Solar Heat Reduction	54%	38%	38%	29%
Heat Loss Reduction	1%	1%	5%	5%
Glare Reduction	72%	70%	71%	69%
UV Blocked	99%	99%	99%	99%
Total Solar Energy Rejected	64%	66%	56%	66%

Technical Data

Glass Type	Applied Product	Shading Coefficient	Visible Light		Visible Light Transmitted	Emissivity	“U” Value
			Exterior Reflection	Interior Reflection			
	None	0.94	8%	8%	88%	0.84	1.06
	S25NVAR400	0.43	28%	13%	24%	0.72	0.82
	None	0.69	5%	5%	50%	0.84	1.06
	S25NVAR400	0.43	13%	13%	15%	0.72	0.82
	None	0.81	14%	14%	78%	0.84	0.50
	S25NVAR400	0.50	28%	13%	23%	0.72	0.42
	None	0.55	8%	8%	45%	0.84	0.50
	S25NVAR400	0.39	15%	15%	14%	0.72	0.42

3M Ultra Safety & Security Window Film





S35NEAR400

Summary



Product Benefits

- Increase personal safety from flying glass.
- Deters smash and grab burglaries.
- Increase protection from windstorms, blasts, and earthquakes.
- Increase daytime privacy.
- Reduces air conditioning costs.
- Stay cooler by reducing excessive heat in warmer months.
- Reduces glare and eye discomfort.
- Furniture and fabrics have a longer acceptable life.

Product Performance

S35NEAR400				
Solar Heat Reduction	45%	35%	28%	22%
Heat Loss Reduction	0%	0%	0%	0%
Glare Reduction	58%	56%	58%	58%
UV Blocked	99%	99%	99%	99%
Total Solar Energy Rejected	56%	61%	50%	63%

Technical Data

Glass Type	Applied Product	Shading Coefficient	Visible Light		Emissivity	“U” Value
			Reflected	Transmitted		
	None	0.94	8%	88%	0.84	1.06
	S35NEAR400	0.51	20%	37%	0.84	1.06
	None	0.69	5%	50%	0.84	1.06
	S35NEAR400	0.45	9%	22%	0.84	1.06
	None	0.81	14%	78%	0.84	0.50
	S35NEAR400	0.58	24%	33%	0.84	0.50
	None	0.55	8%	45%	0.84	0.50
	S35NEAR400	0.43	10%	19%	0.84	0.50

3M Ultra Safety & Security Window Film





S50NEAR400

Summary





Product Benefits

- Increase personal safety from flying glass.
- Deters smash and grab burglaries.
- Increase protection from windstorms, blasts, and earthquakes.
- Increase daytime privacy.
- Reduces air conditioning costs.
- Stay cooler by reducing excessive heat in warmer months.
- Reduces glare and eye discomfort.
- Furniture and fabrics have a longer acceptable life.

Product Performance

S50NEAR400				
Solar Heat Reduction	30%	30%	20%	13%
Heat Loss Reduction	0%	0%	0%	0%
Glare Reduction	42%	50%	42%	38%
UV Blocked	98%	99%	99%	99%
Total Solar Energy Rejected	43%	58%	43%	58%

Technical Data

Glass Type	Applied Product	Shading Coefficient	Visible Light		Emissivity	“U” Value
			Reflected	Transmitted		
	None	0.94	8%	88%	0.84	1.06
	S50NEAR400	0.66	15%	51%	0.84	1.06
	None	0.69	5%	50%	0.84	1.06
	S50NEAR400	0.48	6%	25%	0.84	1.06
	None	0.81	14%	78%	0.84	0.50
	S50NEAR400	0.65	20%	45%	0.84	0.50
	None	0.55	8%	45%	0.84	0.50
	S50NEAR400	0.48	9%	28%	0.84	0.50

3M Safety & Security Window Film





SH4CLARL

Summary





Product Benefits

- Increases personal safety from flying or broken glass.
- Deters smash and grab burglaries.
- Increase protection from windstorms, blasts and earthquakes.
- Reduces fading from UV light. Furniture and fabrics have a longer acceptable life.

Product Performance

SH4CLARL				
Solar Heat Reduction	4%	3%	2%	2%
Heat Loss Reduction	0%	0%	0%	0%
Glare Reduction	5%	4%	12%	8%
UV Blocked	98%	99%	99%	99%
Total Solar Energy Rejected	21%	38%	31%	50%

Technical Data

Glass Type	Applied Product	Shading Coefficient	Visible Light		Visible Light Transmitted	Emissivity	“U” Value
			Exterior Reflection	Interior Reflection			
	None	0.94	8%	8%	88%	0.84	1.06
	SH4CLARL	0.90	9%	8%	88%	0.84	1.04
	None	0.69	5%	5%	50%	0.84	1.06
	SH4CLARL	0.71	6%	6%	53%	0.88	1.04
	None	0.81	14%	14%	78%	0.84	0.50
	SH4CLARL	0.79	15%	15%	78%	0.84	0.48
	None	0.55	8%	8%	45%	0.84	0.50
	SH4CLARL	0.58	9%	13%	47%	0.84	0.48

3M Safety & Security Window Film





SH7CLARL

Summary





Product Benefits

- Increases personal safety from flying or broken glass.
- Deters smash and grab burglaries.
- Increase protection from windstorms, blasts and earthquakes.
- Reduces fading from UV light. Furniture and fabrics have a longer acceptable life.

Product Performance

SH7CLARL				
Solar Heat Reduction	4%	3%	2%	2%
Heat Loss Reduction	0%	0%	0%	0%
Glare Reduction	2%	2%	4%	4%
UV Blocked	98%	99%	99%	99%
Total Solar Energy Rejected	21%	37%	30%	50%

Technical Data

Glass Type	Applied Product	Shading Coefficient	Visible Light		Visible Light Transmitted	Emissivity	“U” Value
			Exterior Reflection	Interior Reflection			
	None	0.94	8%	8%	88%	0.84	1.06
	SH7CLARL	0.90	NA	9%	86%	0.87	1.09
	None	0.69	5%	5%	50%	0.84	1.06
	SH7CLARL	0.67	NA	8%	49%	0.87	1.09
	None	0.81	14%	14%	78%	0.84	0.50
	SH7CLARL	0.79	NA	17%	75%	0.87	0.50
	None	0.55	8%	8%	45%	0.84	0.50
	SH7CLARL	0.54	NA	8%	43%	0.87	0.50

3M Safety & Security Window Film





SH8CLARL

Summary





Product Benefits

- Increases personal safety from flying or broken glass.
- Deters smash and grab burglaries.
- Increase protection from windstorms, blasts and earthquakes.
- Reduces fading from UV light. Furniture and fabrics have a longer acceptable life.

Product Performance

SH8CLARL				
Solar Heat Reduction	3%	1%	1%	2%
Heat Loss Reduction	2%	0%	0%	0%
Glare Reduction	2%	2%	3%	3%
UV Blocked	99%	99%	99%	99%
Total Solar Energy Rejected	21%	37%	30%	50%

Technical Data

Glass Type	Applied Product	Shading Coefficient	Visible Light		Visible Light Transmitted	Emissivity	“U” Value
			Exterior Reflection	Interior Reflection			
	None	0.94	8%	8%	88%	0.84	1.06
	SH8CLARL	0.91	9%	9%	87%	0.89	1.04
	None	0.69	5%	5%	50%	0.84	1.06
	SH8CLARL	0.72	6%	7%	52%	0.89	1.04
	None	0.81	14%	14%	78%	0.84	0.50
	SH8CLARL	0.80	15%	15%	77%	0.89	0.48
	None	0.55	8%	8%	45%	0.84	0.50
	SH8CLARL	0.58	9%	14%	46%	0.89	0.48

3M Safety & Security Window Film





SH14CLARL

Summary





Product Benefits

- Increases personal safety from flying or broken glass.
- Deters smash and grab burglaries.
- Increase protection from windstorms, blasts and earthquakes.
- Reduces fading from UV light. Furniture and fabrics have a longer acceptable life.

Product Performance

SH14CLARL				
Solar Heat Reduction	4%	3%	2%	2%
Heat Loss Reduction	2%	0%	0%	0%
Glare Reduction	4%	4%	9%	3%
UV Blocked	99%	99%	99%	99%
Total Solar Energy Rejected	22%	38%	31%	50%

Technical Data

Glass Type	Applied Product	Shading Coefficient	Visible Light		Visible Light Transmitted	Emissivity	“U” Value
			Exterior Reflection	Interior Reflection			
	None	0.94	8%	8%	88%	0.84	1.06
	SH14CLARL	0.90	10%	10%	85%	0.89	1.04
	None	0.69	5%	5%	50%	0.84	1.06
	SH14CLARL	0.71	6%	8%	51%	0.89	1.04
	None	0.81	14%	14%	78%	0.84	0.50
	SH14CLARL	0.79	16%	16%	72%	0.89	0.48
	None	0.55	8%	8%	45%	0.84	0.50
	SH14CLARL	0.58	9%	15%	46%	0.89	0.48

3M Automotive Window Film





CS-5

Summary





Product Benefits

- Reduces air conditioning cost.
- Reduces glare and eye discomfort.
- Furniture and fabrics have a longer acceptable life.

Product Performance

CS-5				
Solar Heat Reduction	49%	Application not recommended	Application not recommended	Application not recommended
Heat Loss Reduction	NA			
Glare Reduction	91%			
UV Blocked	99%			
Total Solar Energy Rejected	58%			

Technical Data

Glass Type	Applied Product	Shading Coefficient	Visible Light		Visible Light Transmitted	Emissivity	“U” Value
			Exterior Reflection	Interior Reflection			
	None	0.94	8%	8%	88%	0.84	1.06
	CS-5	0.84	NA	5%	7%	0.84	NA
	None	0.69	5%	5%	50%	0.84	1.06
	CS-5	NA	NA	NA	NA	NA	NA
	None	0.81	14%	14%	78%	0.84	0.50
	CS-5	NA	NA	NA	NA	NA	NA
	None	0.55	8%	8%	45%	0.84	0.50
	CS-5	NA	NA	NA	NA	NA	NA

3M Automotive Window Film





CS-20

Summary





Product Benefits

- Reduces air conditioning cost.
- Reduces glare and eye discomfort.
- Furniture and fabrics have a longer acceptable life.

Product Performance

CS-20				
Solar Heat Reduction	41%	34%	19%	16%
Heat Loss Reduction	NA	0%	0%	0%
Glare Reduction	83%	80%	82%	82%
UV Blocked	99%	99%	99%	99%
Total Solar Energy Rejected	53%	57%	45%	56%

Technical Data

Glass Type	Applied Product	Shading Coefficient	Visible Light		Visible Light Transmitted	Emissivity	“U” Value
			Exterior Reflection	Interior Reflection			
	None	0.94	8%	8%	88%	0.84	1.06
	CS-20	0.55	NA	5%	16%	0.84	NA
	None	0.69	5%	5%	50%	0.84	1.06
	CS-20	0.50	NA	4%	10%	0.84	1.06
	None	0.81	14%	14%	78%	0.84	0.50
	CS-20	0.65	NA	13%	14%	0.84	0.50
	None	0.55	8%	8%	45%	0.84	0.50
	CS-20	0.51	NA	6%	8%	0.84	0.48

3M Automotive Window Film





CS-35

Summary





Product Benefits

- Reduces air conditioning cost.
- Reduces glare and eye discomfort.
- Furniture and fabrics have a longer acceptable life.

Product Performance

CS-35				
Solar Heat Reduction	25%	22%	11%	11%
Heat Loss Reduction	0%	0%	0%	0%
Glare Reduction	56%	56%	57%	57%
UV Blocked	98%	99%	99%	99%
Total Solar Energy Rejected	39%	49%	38%	53%

Technical Data

Glass Type	Applied Product	Shading Coefficient	Visible Light		Visible Light Transmitted	Emissivity	"U" Value
			Exterior Reflection	Interior Reflection			
	None	0.94	8%	8%	88%	0.84	1.06
	CS-35	0.70	NA	6%	38%	0.84	NA
	None	0.69	5%	5%	50%	0.84	1.06
	CS-35	0.59	NA	5%	22%	0.84	1.06
	None	0.81	14%	14%	78%	0.84	0.50
	CS-35	0.71	NA	13%	34%	0.84	0.50
	None	0.55	8%	8%	45%	0.84	0.50
	CS-35	0.54	NA	7%	19%	0.84	NA

3M Automotive Window Film





CS-50

Summary





Product Benefits

- Reduces air conditioning cost.
- Reduces glare and eye discomfort.
- Furniture and fabrics have a longer acceptable life.

Product Performance

CS-50				
Solar Heat Reduction	19%	12%	11%	12%
Heat Loss Reduction	2%	0%	0%	0%
Glare Reduction	42%	42%	42%	41%
UV Blocked	97%	99%	97%	99%
Total Solar Energy Rejected	37%	44%	37%	55%

Technical Data

Glass Type	Applied Product	Shading Coefficient	Visible Light		Visible Light Transmitted	Emissivity	“U” Value
			Exterior Reflection	Interior Reflection			
	None	0.94	8%	8%	88%	0.84	1.06
	CS-50	0.77	NA	7%	51%	0.84	NA
	None	0.69	5%	5%	50%	0.84	1.06
	CS-50	0.63	NA	5%	30%	0.84	1.06
	None	0.81	14%	14%	78%	0.84	0.50
	CS-50	0.73	NA	14%	46%	0.84	0.50
	None	0.55	8%	8%	45%	0.84	0.50
	CS-50	0.56	NA	7%	26%	NA	NA

3M Automotive Window Film





BlackChrome 10

Summary





Product Benefits

- Reduces air conditioning cost.
- Reduces glare and eye discomfort.
- Furniture and fabrics have a longer acceptable life.

Product Performance

BlackChrome 10				
Solar Heat Reduction	64%	51%	39%	34%
Heat Loss Reduction	1%	1%	1%	1%
Glare Reduction	88%	87%	87%	87%
UV Blocked	99%	99%	99%	99%
Total Solar Energy Rejected	70%	69%	57%	66%

Technical Data

Glass Type	Applied Product	Shading Coefficient	Visible Light		Visible Light Transmitted	Emissivity	“U” Value
			Exterior Reflection	Interior Reflection			
	None	0.94	8%	8%	88%	0.84	1.06
	BlackChrome 10	0.34	25%	18%	11%	0.81	1.00
	None	0.69	5%	5%	50%	0.84	1.06
	BlackChrome 10	0.36	12%	18%	7%	0.81	1.00
	None	0.81	14%	14%	78%	0.84	0.50
	BlackChrome 10	0.50	28%	19%	10%	0.81	0.46
	None	0.55	8%	8%	45%	0.84	0.50
	BlackChrome 10	0.39	13%	18%	6%	0.81	0.46

3M Automotive Window Film





BlackChrome 20

Summary





Product Benefits

- Reduces air conditioning cost.
- Reduces glare and eye discomfort.
- Furniture and fabrics have a longer acceptable life.

Product Performance

BlackChrome 20				
Solar Heat Reduction	61%	46%	36%	38%
Heat Loss Reduction	7%	6%	4%	5%
Glare Reduction	81%	81%	81%	81%
UV Blocked	99%	99%	99%	99%
Total Solar Energy Rejected	68%	64%	59%	66%

Technical Data

Glass Type	Applied Product	Shading Coefficient	Visible Light		Visible Light Transmitted	Emissivity	“U” Value
			Exterior Reflection	Interior Reflection			
	None	0.94	8%	8%	88%	0.84	1.06
	BlackChrome 20	0.37	21%	25%	17%	0.81	0.95
	None	0.69	5%	5%	50%	0.84	1.06
	BlackChrome 20	0.41	15%	25%	12%	0.81	0.78
	None	0.81	14%	14%	78%	0.84	0.50
	BlackChrome 20	0.47	21%	25%	13%	0.81	0.45
	None	0.55	8%	8%	45%	0.84	0.50
	BlackChrome 20	0.39	11%	25%	9%	0.81	0.62

3M Automotive Window Film





BlackChrome 35

Summary





Product Benefits

- Reduces air conditioning cost.
- Reduces glare and eye discomfort.
- Furniture and fabrics have a longer acceptable life.

Product Performance

BlackChrome 35				
Solar Heat Reduction	47%	38%	26%	24%
Heat Loss Reduction	4%	4%	2%	2%
Glare Reduction	66%	66%	66%	66%
UV Blocked	99%	99%	99%	99%
Total Solar Energy Rejected	57%	61%	48%	61%

Technical Data

Glass Type	Applied Product	Shading Coefficient	Visible Light		Visible Light Transmitted	Emissivity	"U" Value
			Exterior Reflection	Interior Reflection			
	None	0.94	8%	8%	88%	0.84	1.06
	BlackChrome 35	0.50	13%	14%	30%	0.81	.98
	None	0.69	5%	5%	50%	0.84	1.06
	BlackChrome 35	0.45	8%	14%	18%	0.81	.98
	None	0.81	14%	14%	78%	0.84	0.50
	BlackChrome 35	0.60	19%	15%	27%	0.81	0.46
	None	0.55	8%	8%	45%	0.84	0.50
	BlackChrome 35	0.45	10%	15%	16%	0.81	0.46

3M Automotive Window Film





BlackChrome 40

Summary





Product Benefits

- Reduces air conditioning cost.
- Reduces glare and eye discomfort.
- Furniture and fabrics have a longer acceptable life.

Product Performance

BlackChrome 40				
Solar Heat Reduction	36%	30%	19%	18%
Heat Loss Reduction	7%	7%	4%	4%
Glare Reduction	54%	50%	53%	51%
UV Blocked	99%	99%	99%	99%
Total Solar Energy Rejected	48%	55%	43%	58%

Technical Data

Glass Type	Applied Product	Shading Coefficient	Visible Light		Visible Light Transmitted	Emissivity	"U" Value
			Exterior Reflection	Interior Reflection			
	None	0.94	8%	8%	88%	0.84	1.06
	BlackChrome 40	0.60	10%	8%	41%	0.81	.95
	None	0.69	5%	5%	50%	0.84	1.06
	BlackChrome 40	0.51	6%	8%	25%	0.81	.95
	None	0.81	14%	14%	78%	0.84	0.50
	BlackChrome 40	0.65	16%	10%	37%	0.81	0.45
	None	0.55	8%	8%	45%	0.84	0.50
	BlackChrome 40	0.49	9%	9%	22%	0.81	0.45





3M Automotive Window Film

FX HP-5 Summary





Product Benefits

- Reduces air conditioning cost.
- Reduces glare and eye discomfort.
- Furniture and fabrics have a longer acceptable life.

Product Performance

FX HP-5				
Solar Heat Reduction	43%	34%	21%	19%
Heat Loss Reduction	2%	0%	0%	0%
Glare Reduction	97%	96%	96%	96%
UV Blocked	99%	99%	99%	99%
Total Solar Energy Rejected	53%	58%	44%	58%

Technical Data

Glass Type	Applied Product	Shading Coefficient	Visible Light		Visible Light Transmitted	Emissivity	“U” Value
			Exterior Reflection	Interior Reflection			
	None	0.94	8%	8%	88%	0.84	1.06
	FX HP-5	0.54	5%	5%	3%	0.84	1.04
	None	0.69	5%	5%	50%	0.84	1.06
	FX HP-5	0.48	5%	5%	2%	0.84	1.04
	None	0.81	14%	14%	78%	0.84	0.50
	FX HP-5	0.64	12%	5%	3%	0.84	0.48
	None	0.55	8%	8%	45%	0.84	0.50
	FX HP-5	0.48	7%	5%	20%	0.88	0.48

3M Automotive Window Film





FX HP-15

Summary





Product Benefits

- Reduces air conditioning cost.
- Reduces glare and eye discomfort.
- Furniture and fabrics have a longer acceptable life.

Product Performance

FX HP-15				
Solar Heat Reduction	39%	33%	20%	17%
Heat Loss Reduction	3%	3%	2%	2%
Glare Reduction	84%	85%	85%	85%
UV Blocked	97%	99%	97%	99%
Total Solar Energy Rejected	50%	57%	43%	57%

Technical Data

Glass Type	Applied Product	Shading Coefficient	Visible Light		Visible Light Transmitted	Emissivity	“U” Value
			Exterior Reflection	Interior Reflection			
	None	0.94	8%	8%	88%	0.84	1.06
	FX HP-15	0.57	5%	7%	14%	0.77	0.99
	None	0.69	5%	5%	50%	0.84	1.06
	FX HP-15	0.49	5%	7%	8%	0.77	0.99
	None	0.81	14%	14%	78%	0.84	0.50
	FX HP-15	0.65	12%	7%	12%	0.77	0.46
	None	0.55	8%	8%	45%	0.84	0.50
	FX HP-15	0.49	8%	7%	7%	0.77	0.46

3M Automotive Window Film





FX HP-20

Summary





Product Benefits

- Reduces air conditioning cost.
- Reduces glare and eye discomfort.
- Furniture and fabrics have a longer acceptable life.

Product Performance

FX HP-20				
Solar Heat Reduction	37%	30%	19%	17%
Heat Loss Reduction	4%	0%	0%	0%
Glare Reduction	74%	74%	75%	75%
UV Blocked	97%	99%	97%	99%
Total Solar Energy Rejected	49%	56%	43%	57%

Technical Data

Glass Type	Applied Product	Shading Coefficient	Visible Light		Visible Light Transmitted	Emissivity	“U” Value
			Exterior Reflection	Interior Reflection			
	None	0.94	8%	8%	88%	0.84	1.06
	FX HP-20	0.59	5%	9%	23%	0.84	1.02
	None	0.69	5%	5%	50%	0.84	1.06
	FX HP-20	0.51	5%	9%	14%	0.84	1.02
	None	0.81	14%	14%	78%	0.84	0.50
	FX HP-20	0.66	13%	9%	20%	0.84	0.47
	None	0.55	8%	8%	45%	0.84	0.50
	FX HP-20	0.49	8%	9%	12%	0.84	0.47

3M Automotive Window Film





FX HP-30

Summary





Product Benefits

- Reduces air conditioning cost.
- Reduces glare and eye discomfort.
- Furniture and fabrics have a longer acceptable life.

Product Performance

FX HP-30				
Solar Heat Reduction	33%	26%	16%	14%
Heat Loss Reduction	2%	0%	0%	0%
Glare Reduction	65%	64%	65%	64%
UV Blocked	99%	99%	99%	99%
Total Solar Energy Rejected	45%	53%	41%	56%

Technical Data

Glass Type	Applied Product	Shading Coefficient	Visible Light		Visible Light Transmitted	Emissivity	“U” Value
			Exterior Reflection	Interior Reflection			
	None	0.94	8%	8%	88%	0.84	1.06
	FX HP-30	0.63	6%	8%	31%	0.84	1.04
	None	0.69	5%	5%	50%	0.84	1.06
	FX HP-30	0.54	5%	8%	19%	0.84	1.04
	None	0.81	14%	14%	78%	0.84	0.50
	FX HP-30	0.68	13%	9%	28%	0.84	0.48
	None	0.55	8%	8%	45%	0.84	0.50
	FX HP-30	0.51	8%	9%	17%	0.88	0.48

3M Automotive Window Film





FX HP-35

Summary





Product Benefits

- Reduces air conditioning cost.
- Reduces glare and eye discomfort.
- Furniture and fabrics have a longer acceptable life.

Product Performance

FX HP-35				
Solar Heat Reduction	29%	23%	14%	12%
Heat Loss Reduction	2%	0%	0%	0%
Glare Reduction	54%	53%	53%	54%
UV Blocked	97%	99%	97%	99%
Total Solar Energy Rejected	42%	51%	39%	55%

Technical Data

Glass Type	Applied Product	Shading Coefficient	Visible Light		Visible Light Transmitted	Emissivity	“U” Value
			Exterior Reflection	Interior Reflection			
	None	0.94	8%	8%	88%	0.84	1.06
	FX HP-35	0.67	7%	8%	41%	0.84	1.04
	None	0.69	5%	5%	50%	0.84	1.06
	FX HP-35	0.56	5%	8%	25%	0.84	1.04
	None	0.81	14%	14%	78%	0.84	0.50
	FX HP-35	0.70	14%	10%	37%	0.84	0.48
	None	0.55	8%	8%	45%	0.84	0.50
	FX HP-35	0.52	8%	9%	22%	0.88	0.48

3M Automotive Window Film





FX HP-50

Summary





Product Benefits

- Reduces air conditioning cost.
- Reduces glare and eye discomfort.
- Furniture and fabrics have a longer acceptable life.

Product Performance

FX HP-50				
Solar Heat Reduction	27%	21%	14%	12%
Heat Loss Reduction	2%	0%	0%	0%
Glare Reduction	45%	45%	46%	45%
UV Blocked	99%	99%	99%	99%
Total Solar Energy Rejected	40%	50%	39%	55%

Technical Data

Glass Type	Applied Product	Shading Coefficient	Visible Light		Visible Light Transmitted	Emissivity	“U” Value
			Exterior Reflection	Interior Reflection			
	None	0.94	8%	8%	88%	0.84	1.06
	FX HP-50	0.69	8%	8%	49%	0.84	1.04
	None	0.69	5%	5%	50%	0.84	1.06
	FX HP-50	0.58	6%	7%	29%	0.84	1.04
	None	0.81	14%	14%	78%	0.84	0.50
	FX HP-50	0.70	15%	10%	43%	0.84	0.48
	None	0.55	8%	8%	45%	0.84	0.50
	FX HP-50	0.52	10%	8%	26%	0.88	0.48

3M Automotive Window Film





FX ST-5

Summary





Product Benefits

- Reduces air conditioning cost.
- Reduces glare and eye discomfort.
- Furniture and fabrics have a longer acceptable life.

Product Performance

FX ST-5				
Solar Heat Reduction	33%	33%	16%	14%
Heat Loss Reduction	4%	0%	0%	0%
Glare Reduction	95%	96%	95%	96%
UV Blocked	99%	99%	99%	99%
Total Solar Energy Rejected	45%	53%	41%	56%

Technical Data

Glass Type	Applied Product	Shading Coefficient	Visible Light		Visible Light Transmitted	Emissivity	“U” Value
			Exterior Reflection	Interior Reflection			
	None	0.94	8%	8%	88%	0.84	1.06
	FX ST-5	0.63	5%	4%	4%	0.84	1.02
	None	0.69	5%	5%	50%	0.84	1.06
	FX ST-5	0.54	5%	4%	3%	0.84	1.02
	None	0.81	14%	14%	78%	0.84	0.50
	FX ST-5	0.68	12%	5%	4%	0.84	0.47
	None	0.55	8%	8%	45%	0.84	0.50
	FX ST-5	0.51	7%	5%	2%	0.84	0.47

3M Automotive Window Film





FX ST-20

Summary





Product Benefits

- Reduces air conditioning cost.
- Reduces glare and eye discomfort.
- Furniture and fabrics have a longer acceptable life.

Product Performance

FX ST-20				
Solar Heat Reduction	26%	19%	12%	10%
Heat Loss Reduction	2%	0%	0%	0%
Glare Reduction	74%	74%	73%	75%
UV Blocked	99%	99%	99%	99%
Total Solar Energy Rejected	39%	49%	38%	54%

Technical Data

Glass Type	Applied Product	Shading Coefficient	Visible Light		Visible Light Transmitted	Emissivity	“U” Value
			Exterior Reflection	Interior Reflection			
	None	0.94	8%	8%	88%	0.84	1.06
	FX ST-20	0.70	5%	5%	23%	0.84	1.04
	None	0.69	5%	5%	50%	0.84	1.06
	FX ST-20	0.59	5%	4%	14%	0.84	1.04
	None	0.81	14%	14%	78%	0.84	0.50
	FX ST-20	0.71	12%	5%	21%	0.84	0.48
	None	0.55	8%	8%	45%	0.84	0.50
	FX ST-20	0.53	7%	5%	12%	0.88	0.48

3M Automotive Window Film





FX ST-35

Summary





Product Benefits

- Reduces air conditioning cost.
- Reduces glare and eye discomfort.
- Furniture and fabrics have a longer acceptable life.

Product Performance

FX ST-35				
Solar Heat Reduction	21%	16%	10%	8%
Heat Loss Reduction	2%	0%	0%	0%
Glare Reduction	63%	62%	62%	62%
UV Blocked	99%	99%	99%	99%
Total Solar Energy Rejected	36%	47%	36%	53%

Technical Data

Glass Type	Applied Product	Shading Coefficient	Visible Light		Visible Light Transmitted	Emissivity	"U" Value
			Exterior Reflection	Interior Reflection			
	None	0.94	8%	8%	88%	0.84	1.06
	FX ST-35	0.74	5%	5%	33%	0.84	1.04
	None	0.69	5%	5%	50%	0.84	1.06
	FX ST-35	0.61	5%	5%	20%	0.84	1.04
	None	0.81	14%	14%	78%	0.84	0.50
	FX ST-35	0.73	12%	6%	30%	0.84	0.48
	None	0.55	8%	8%	45%	0.84	0.50
	FX ST-35	0.54	7%	6%	18%	0.88	.48

3M Automotive Window Film





FX ST-40

Summary





Product Benefits

- Reduces air conditioning cost.
- Reduces glare and eye discomfort.
- Furniture and fabrics have a longer acceptable life.

Product Performance

FX ST-40				
Solar Heat Reduction	19%	15%	9%	8%
Heat Loss Reduction	2%	0%	0%	0%
Glare Reduction	54%	53%	54%	54%
UV Blocked	99%	99%	99%	99%
Total Solar Energy Rejected	34%	46%	36%	53%

Technical Data

Glass Type	Applied Product	Shading Coefficient	Visible Light		Visible Light Transmitted	Emissivity	“U” Value
			Exterior Reflection	Interior Reflection			
	None	0.94	8%	8%	88%	0.84	1.06
	FX ST-40	0.76	5%	5%	41%	0.88	1.04
	None	0.69	5%	5%	50%	0.84	1.06
	FX ST-40	0.62	5%	5%	25%	0.88	1.04
	None	0.81	14%	14%	78%	0.84	0.50
	FX ST-40	0.74	12%	7%	36%	0.88	0.48
	None	0.55	8%	8%	45%	0.84	0.50
	FX ST-40	0.54	7%	6%	22%	0.88	0.48

3M Automotive Window Film





FX ST-50

Summary





Product Benefits

- Reduces air conditioning cost.
- Reduces glare and eye discomfort.
- Furniture and fabrics have a longer acceptable life.

Product Performance

FX ST-50				
Solar Heat Reduction	14%	11%	6%	7%
Heat Loss Reduction	2%	0%	0%	0%
Glare Reduction	39%	40%	39%	39%
UV Blocked	98%	99%	99%	99%
Total Solar Energy Rejected	30%	43%	34%	52%

Technical Data

Glass Type	Applied Product	Shading Coefficient	Visible Light		Visible Light Transmitted	Emissivity	“U” Value
			Exterior Reflection	Interior Reflection			
	None	0.94	8%	8%	88%	0.84	1.06
	FX ST-50	0.81	6%	6%	54%	0.88	1.04
	None	0.69	5%	5%	50%	0.84	1.06
	FX ST-50	0.50	5%	5%	32%	0.88	1.04
	None	0.81	14%	14%	78%	0.84	0.50
	FX ST-50	0.76	13%	8%	48%	0.88	0.48
	None	0.55	8%	8%	45%	0.84	0.50
	FX ST-50	0.55	8%	8%	29%	0.88	0.48

3M Window Film





CI100B

Summary





Product Benefits

- Counter intelligence film
- Reduces air conditioning cost.
- Reduces glare and eye discomfort.
- Furniture and fabrics have a longer acceptable life.

Product Performance

CI100B 6mm				
Solar Heat Reduction	50%	41%	32%	29%
Heat Loss Reduction	6%	6%	2%	2%
Glare Reduction	23%	23%	23%	24%
UV Blocked	99%	99%	99%	99%
Total Solar Energy Rejected	59%	63%	52%	63%

Technical Data

Glass Type	Applied Product	Shading Coefficient	Visible Light		Visible Light Transmitted	Emissivity	“U” Value
			Exterior Reflection	Interior Reflection			
	None	0.94	8%	8%	88%	0.84	1.06
	CI100B	0.47	11%	11%	68%	0.73	.96
	None	0.69	5%	5%	50%	0.84	1.06
	CI100B	0.43	7%	9%	41%	0.73	.96
	None	0.81	14%	14%	78%	0.84	0.50
	CI100B	0.55	17%	15%	61%	0.73	0.46
	None	0.55	8%	8%	45%	0.84	0.50
	CI100B	0.42	9%	14%	36%	0.73	0.46

3M Window Film





CI100T

Summary





Product Benefits

- Counter intelligence film
- Reduces air conditioning cost.
- Reduces glare and eye discomfort.
- Furniture and fabrics have a longer acceptable life.

Product Performance

CI100T 6mm				
Solar Heat Reduction	49%	40%	32%	29%
Heat Loss Reduction	5%	5%	2%	2%
Glare Reduction	21%	21%	20%	22%
UV Blocked	100%	100%	100%	100%
Total Solar Energy Rejected	58%	62%	52%	63%

Technical Data

Glass Type	Applied Product	Shading Coefficient	Visible Light		Visible Light Transmitted	Emissivity	“U” Value
			Exterior Reflection	Interior Reflection			
	None	0.94	8%	8%	88%	0.84	1.06
	CI100T	0.48	8%	9%	70%	0.73	.97
	None	0.69	5%	5%	50%	0.84	1.06
	CI100T	0.44	6%	7%	42%	0.73	.97
	None	0.81	14%	14%	78%	0.84	0.50
	CI100T	0.55	15%	13%	63%	0.73	0.46
	None	0.55	8%	8%	45%	0.84	0.50
	CI100T	0.42	8%	12%	37%	0.73	0.46

3M Fasara Interior Design Films

PRODUCTS

Glass Shade Series	Product Name	Product Size
• SH2PTA SA	Sagano	50" x 98.4'
• SH2EM OS	Oslo	50" x 98.4'
• SH2PT YA	Yamato	50" x 98.4'
• SH2EM LA	Lausanne	50" x 98.4'
Glass Deco Series		
• SH2MA ML	Milano	50" x 196.8'
		60" x 196.8'
• SH2MA MM	San Marino	50" x 98.4'

FEATURES & BENEFITS

3M™ Fasara™ Interior Design films from Japan will add a new dimension to space. Decorative films are applied to glass creating a beautiful etched-glass appearance without the etched-glass cost. The new films create a uniform rice paper appearance not typically found in window films. Light is dispersed softly, rendering a high-class, tranquil atmosphere. We have premium Interior Design films suited for interior glass partitions or the inside surface of windows. Developed for the Asian market, the Fasara films offer the opportunity to immerse oneself in the aesthetic serenity distinctive to the Japanese culture, while still maintaining the outstanding quality provided by 3M technology.

- Architectural applications
- Privacy and decorative
- Window graphic applications
- Unique rice paper designs (Sagano and Yamato)
- Emulates etched or sand blasted glass (Oslo and Lausanne)
- All designs are uniform throughout the film
- Blocks up to 99% UV which assists in reducing fade on fabrics
- Glare and heat reduction
- Fingerprint resistant – Glass Shade Series
- Durable polyester film
- Increases personal safety from flying glass
- Easy to clean
- Can be removed when required

SELLING TIPS

- Look for creative locations to apply decorative film while bidding on 3M™ Scotchtint™ or 3M™ Scotchshield™ window films for interior glass and window applications.
 - Offices
 - Restaurants
 - Hotels
 - Retail Windows & Doors
- For unique graphic applications, establish a relationship with a sign company to create and cut the film to the customer's specifications. Negotiate rate with sign company prior to forwarding the estimate to the customer.
- Etched-glass can be costly, difficult to clean, expensive and a hassle to replace if damaged. Acknowledge these challenges when approaching customers.
- Etching can weaken glass. Film helps to reinforce the glass.

PRODUCT DESCRIPTION

The 3M™ Fasara™ Interior Design films are recommended for application to interior glass and exterior glass (inside surface). These films are made of durable polyester with a decorative matte surface, perfect for privacy, decorative and architectural applications. The Fasara™ films are not recommended for use on glass substitutes (i.e. plastics). The total nominal thickness is between 3.0 and 3.5 mils, depending on film type. These films are manufactured with a silicone liner, which protects the clear pressure-sensitive adhesive, and, except for the absence of an overcoat, are applied using the same tools and techniques you are accustomed to with other Scotchtint films.

PERFORMANCE SPECIFICATION for 1/4" (6mm) GLASS

Product	UV Blocked	Visible Light Transmitted	Visible Light Reflected	Glare Reduction	Solar Heat Reduction	Shading Coefficient
SH2MA ML Milano	99%	59%	17%	33%	21%	0.75
SH2PT SA Sagano	99%	52%	15%	41%	21%	0.75
SH2PT YA Yamato	99%	53%	16%	40%	21%	0.75
SH2EM OS Oslo	99%	77%	9%	12%	6%	0.89
SH2EM LA Lausanne	99%	82%	9%	7%	5%	0.90
SH2MA MM San Marino	99%	28%	27%	69%	42%	0.55

INSTALLATION TIPS & TECHNIQUES

- Customer should provide clear access to work areas
- Protect floor, carpet, window ledge, wall, etc., with suitable absorbent material (drop cloth)
- Turn off or cover heating / AC and ventilation ducts
- Wipe down window frame with damp cloth or sponge
- If window putty or seal is old and cracked, tape or seal prior to washing glass
- Using 90% water to 10% ammonia, clean glass with a blade scraper
- Thoroughly rinse glass from top to bottom with pressure spray tank
- Squeegee entire glass surface
- Dry glass edges and window frames using a lint-free towel
- Measure glass and precut film to fit or,
- Cut film to fit or cut 1" wider and 1" longer then trim film to size after first squeegee
- Spray slip solution, composed of one capful of Johnson® Baby Shampoo or Joy® Dishwashing Liquid to 1 gallon of water, to glass and film. Use no more soap than is needed to provide slip.
- Apply film to glass and lightly spray film with slip solution
- Squeegee to remove the water
- If you did not cut film to size, trim the film to size before you squeegee the second time
- Spray slip solution to the film and squeegee the second time
- Always use new blade tip after 3-4 cuts
- Bump film edge with a lint-free towel wrapped around the edge of a five-way tool
- Wipe frame edge dry
- Inspect installation to insure high quality of the application

WINDOW CARE

Fasara Window Films may be washed with common washing solutions, including ammonia-based cleaners, thirty (30) days after installation. Abrasive type cleaning agents and brushes, which would scratch the film, must not be used. These films may also be cleaned with a mild dishwashing soap such as Ivory Liquid® and a synthetic sponge, squeegee or soft cloth.

INSTALLATION TIPS & TECHNIQUES

- Customer should provide clear access to work areas
- Protect floor, carpet, window ledge, wall, etc., with suitable absorbent material (drop cloth)
- Turn off or cover heating / AC and ventilation ducts
- Wipe down window frame with damp cloth or sponge
- If window putty or seal is old and cracked, tape or seal prior to washing glass
- Using 90% water to 10% ammonia, clean glass with a blade scraper
- Thoroughly rinse glass from top to bottom with pressure spray tank
- Squeegee entire glass surface
- Dry glass edges and window frames using a lint-free towel
- Measure glass and precut film to fit or,
- Cut film to fit or cut 1" wider and 1" longer then trim film to size after first squeegee
- Spray slip solution, composed of one capful of Johnson® Baby Shampoo or Joy® Dishwashing Liquid to 1 gallon of water, to glass and film. Use no more soap than is needed to provide slip.
- Apply film to glass and lightly spray film with slip solution
- Squeegee to remove the water
- If you did not cut film to size, trim the film to size before you squeegee the second time
- Spray slip solution to the film and squeegee the second time
- Always use new blade tip after 3-4 cuts
- Bump film edge with a lint-free towel wrapped around the edge of a five-way tool
- Wipe frame edge dry
- Inspect installation to insure high quality of the application

WINDOW CARE

Fasara Window Films may be washed with common washing solutions, including ammonia-based cleaners, thirty (30) days after installation. Abrasive type cleaning agents and brushes, which would scratch the film, must not be used. These films may also be cleaned with a mild dishwashing soap such as Ivory Liquid® and a synthetic sponge, squeegee or soft cloth.

General Information

How Film Works

- Electromagnetic Spectrum
- Solar Spectrum
- Wavelength
- Solar Radiation
- Total Solar Energy
- Shading Coefficient
- Emissivity
- “U” Value/“K” Value
- “R” Value
- Calculating Solar Energy Reductions
- Heat Transfer
 - BTU - British Thermal Unit
 - Methods of Heat Transfer
 - Radiation
 - Conduction
 - Convection
 - Solar Heat Gain
 - Summer Heat Gain
 - TON - HR
 - Winter Heat Loss
- General Background
- Top 20 Questions and Answers
- Fading
- Longevity

EMI

- Background and Definitions
- Test Results
- Effects on House Plants
- Manufacturing Process

How Film Works

Electromagnetic Spectrum

Solar Spectrum

Wavelength

Solar Radiation

Total Solar Energy

Shading Coefficient

Emissivity

“U” Value/“K” Value

“R” Value

Calculating Solar Energy Reductions

Top 20 Questions and Answers

Fading

Longevity

Storage Conditions

ELECTROMAGNETIC SPECTRUM

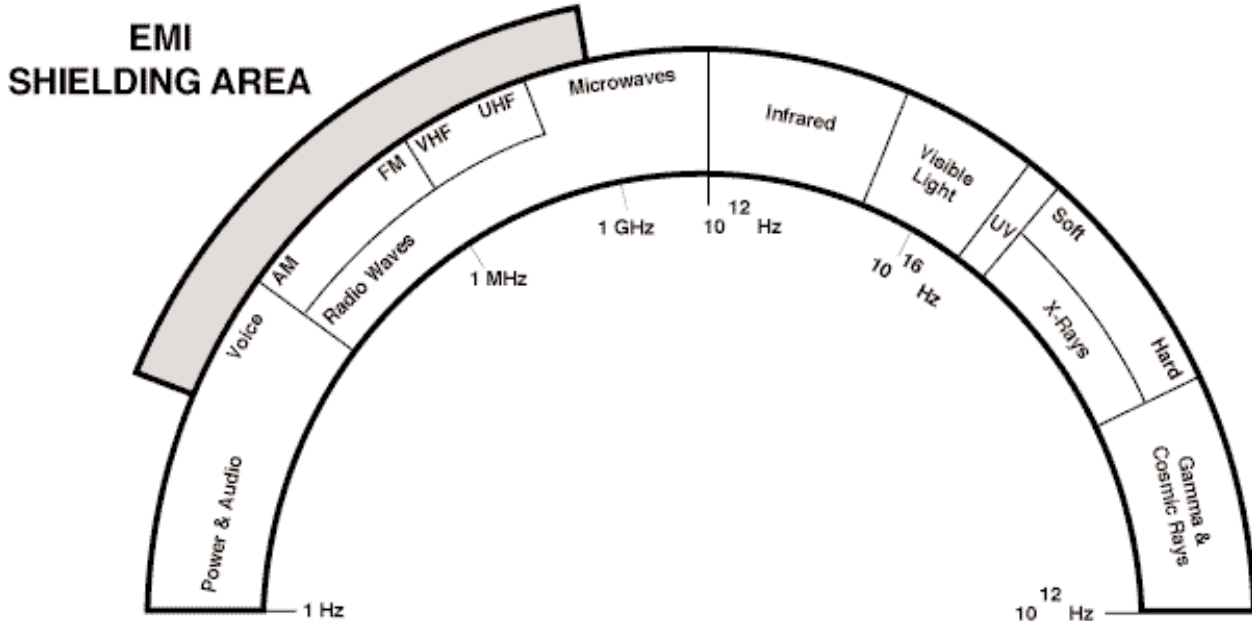

SOLAR SPECTRUM

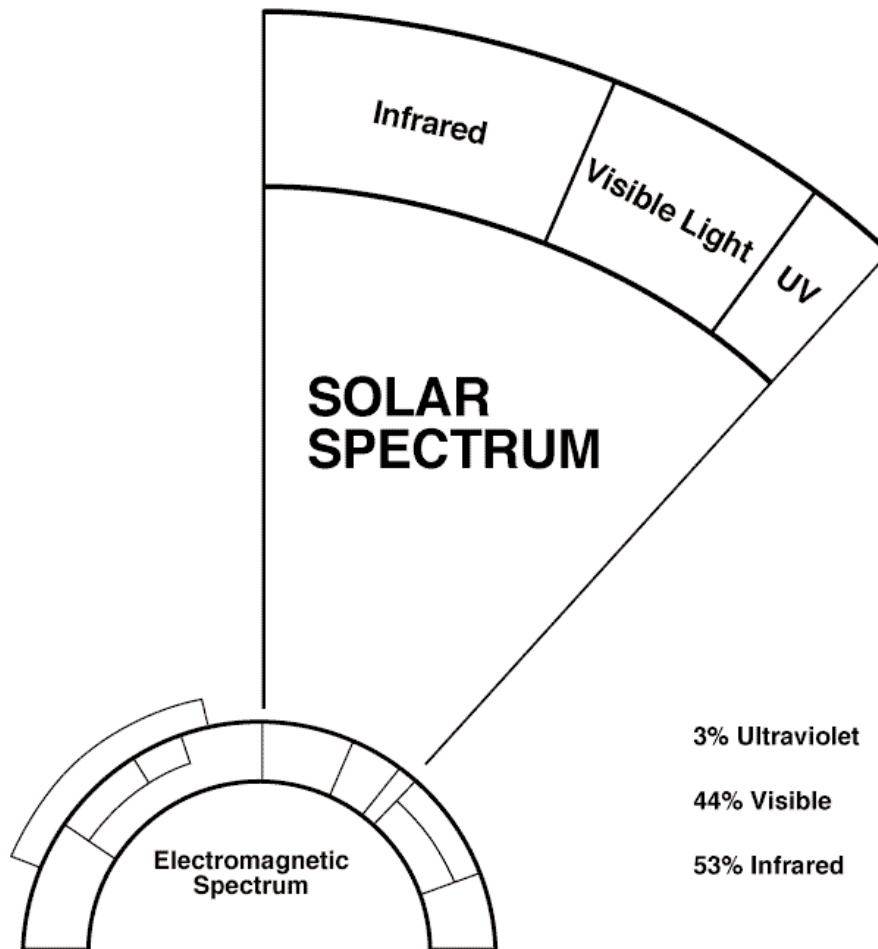

General Information

WAVELENGTH



One Nanometer = .000000001 meters

SOLAR RADIATION

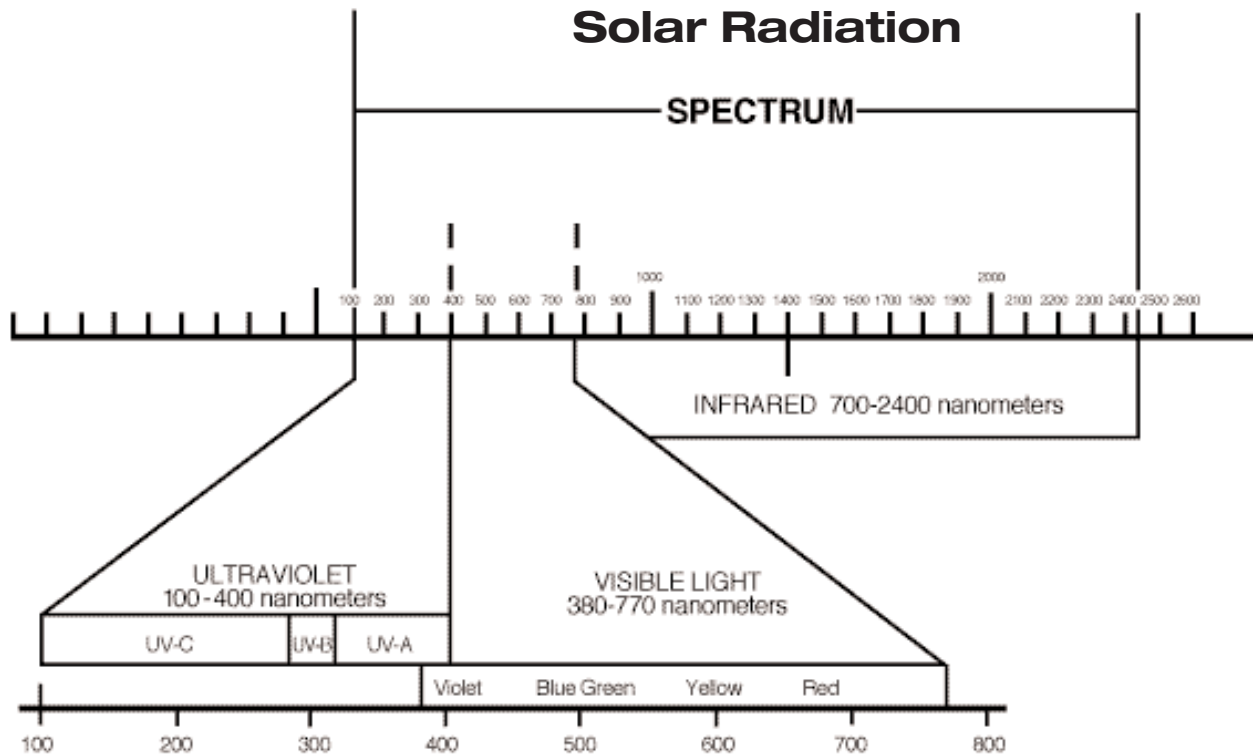

TOTAL SOLAR ENERGY

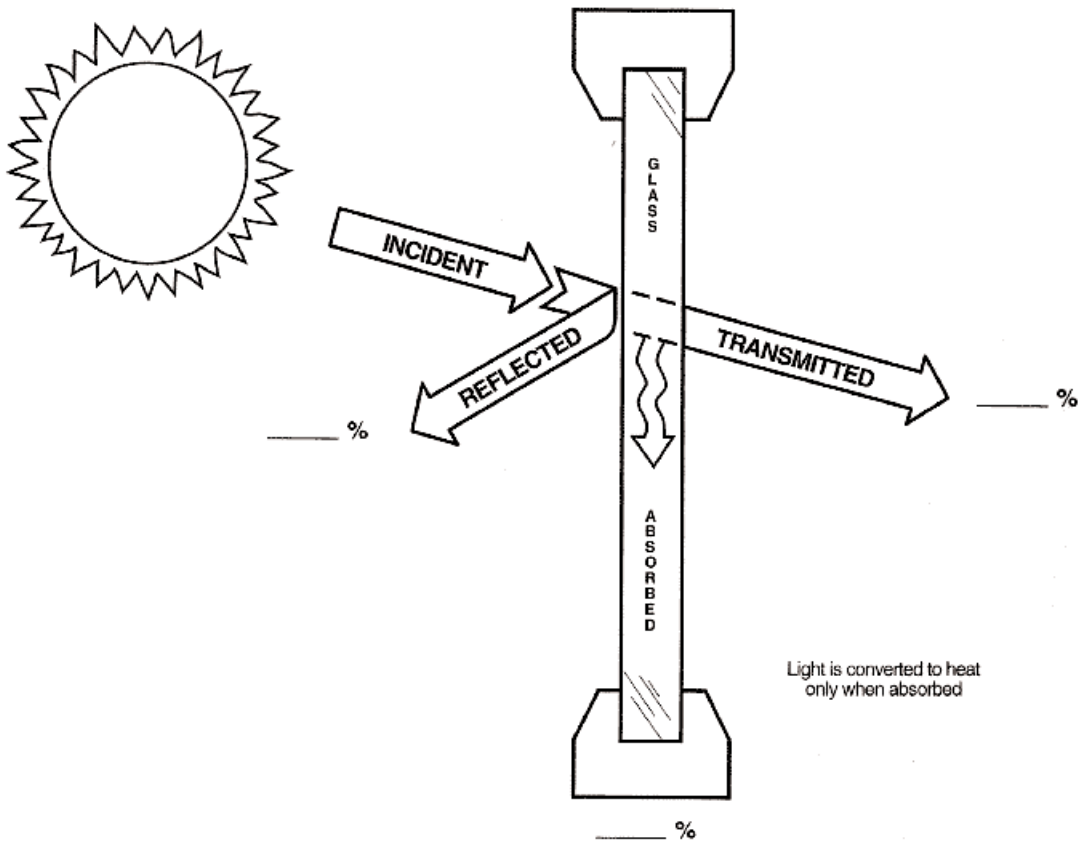

General Information

SHADING COEFFICIENT

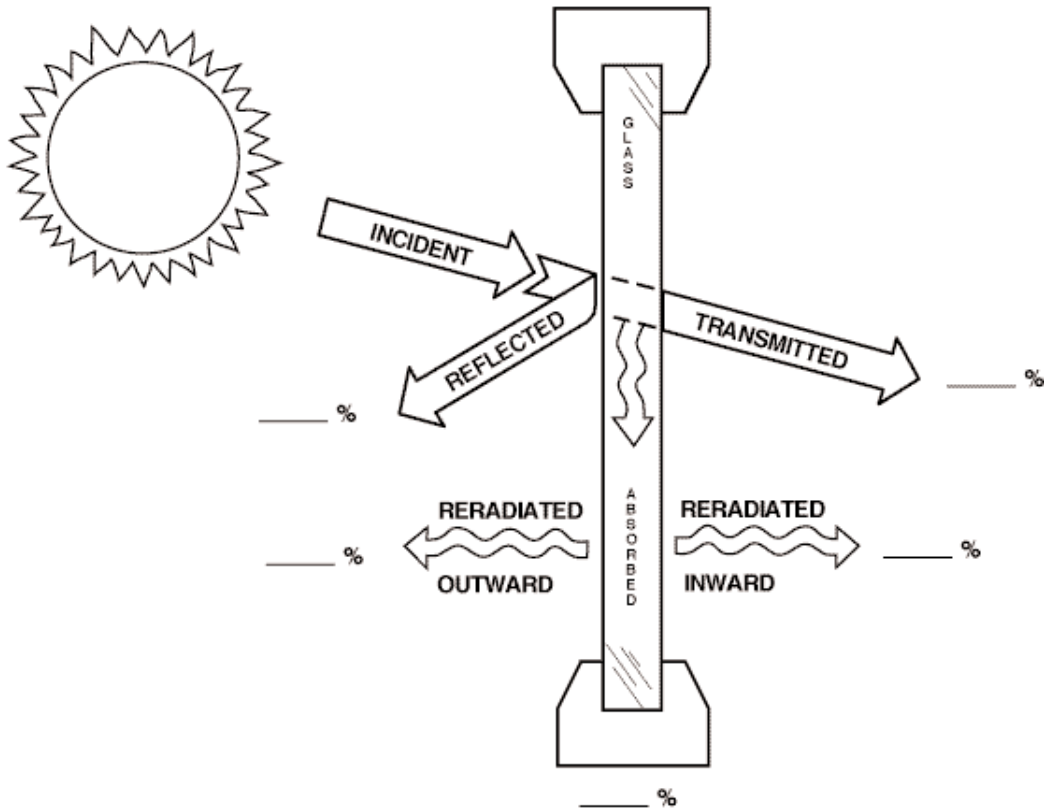

EMISSIVITY

The ability of a surface to absorb heat and to reflect it

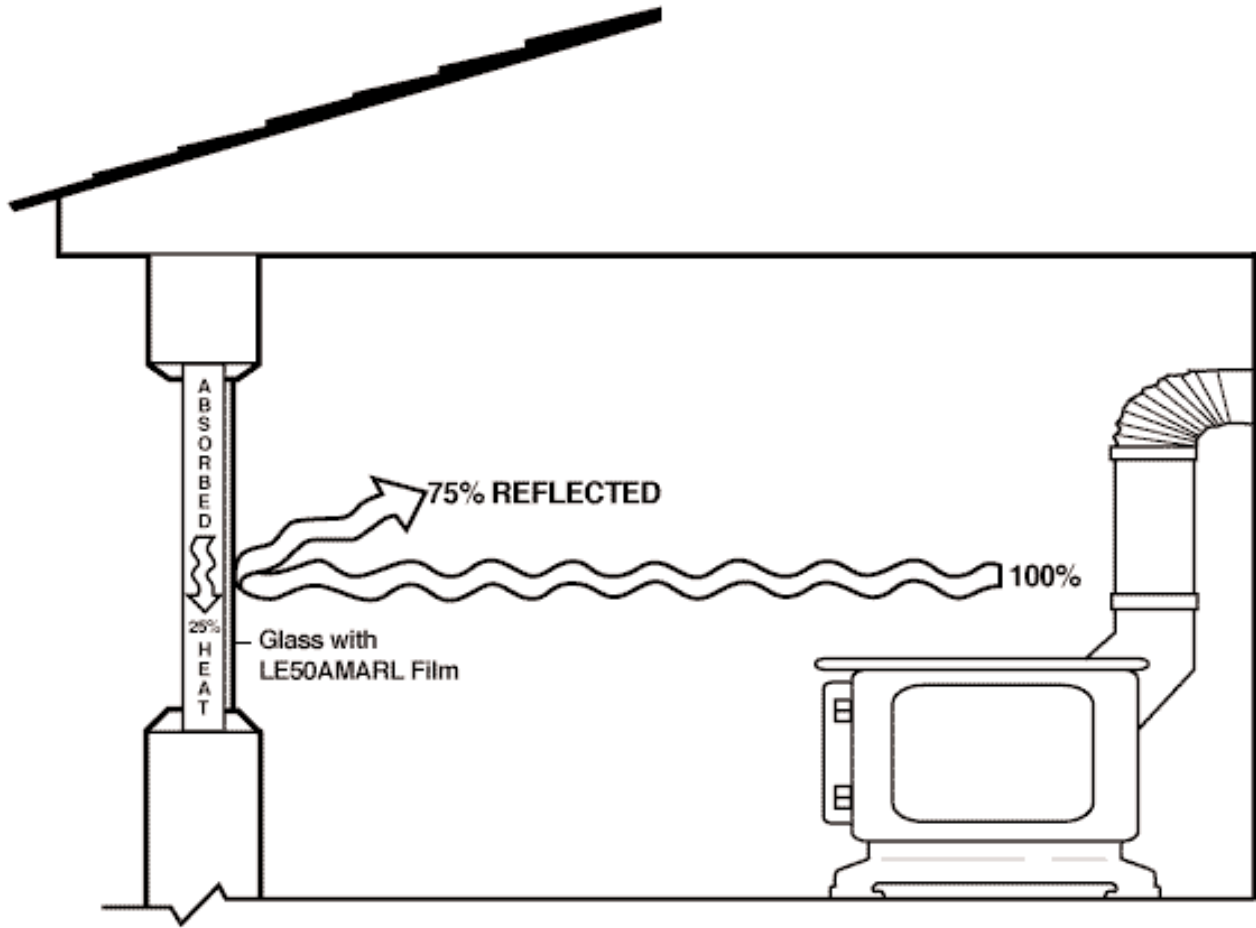

General Information

Emissivity of Some Materials

Gold, Polished	0.02
Silver, Polished	0.02
Aluminum, Polished	0.05
3M™ Scotchtint™ LE35AMARL Film	0.34
3M™ Scotchtint™ P-18ARL Film	0.65
Glass	0.84
Paper	0.89
Wood	0.91
White Enamel	0.91
Flat Black Lacquer	0.96

“U” VALUE/“K” VALUE

The amount of heat passing through 1 sq. ft. (.092 sq meters) of glass in 1 hour for every 1° F (0.47° C) temperature difference

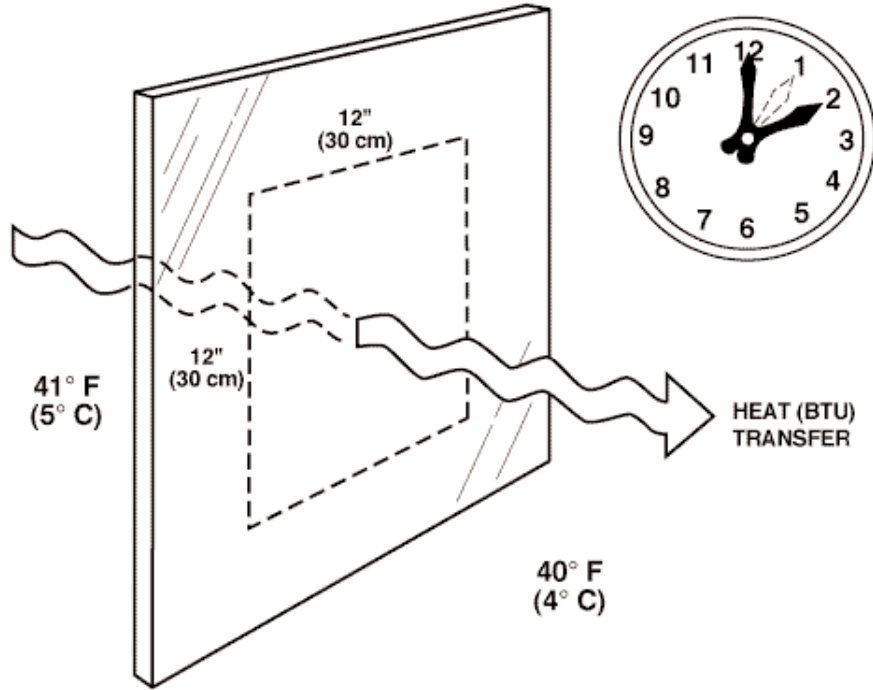

General Information

“R” VALUE

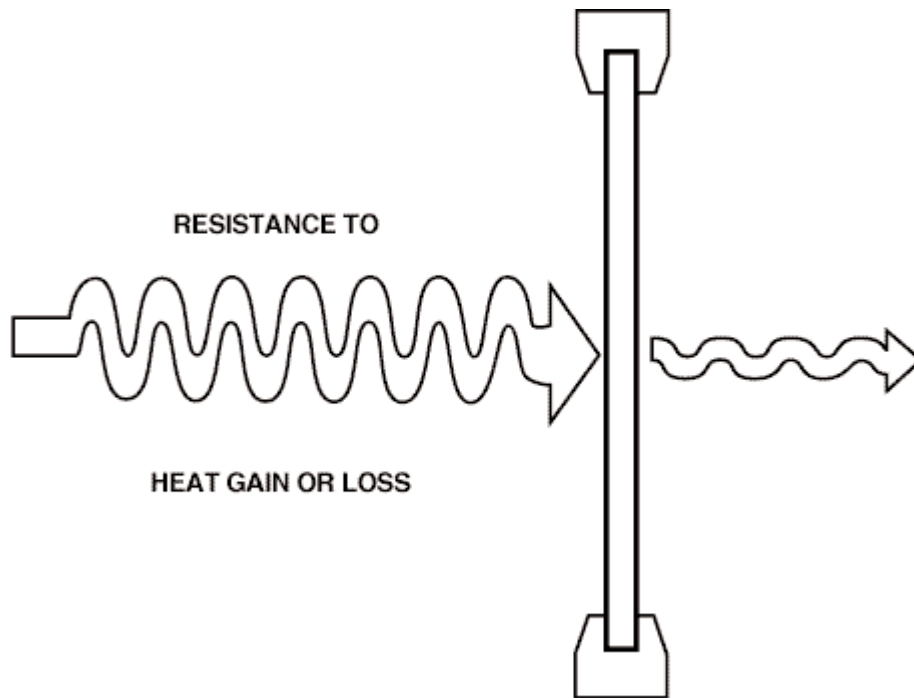

Reciprocal of “U” Value

$$“R” = 1/“U”$$

$$“U” = 1/“R”$$

CALCULATING SOLAR ENERGY REDUCTIONS

Formula	Example LE35AMARL	
Solar Heat Reduction		
(Shading Coefficient of Glass) - (Shading Coefficient of Glass w/Film)	<u>0.94 - 0.29</u>	= 69%
Shading Coefficient of Glass	0.94	
Heat Loss Reduction		
(U-Value of Glass) - (U-Value of Glass w/Film)	<u>1.06 - 0.74</u>	= 30%
U-Value of Glass	1.06	
Glare Reduction		
(Visible Light Transmission of Glass) - (Visible Light Transmission of Glass with Film)	<u>88 - 31</u>	= 65%
Visible Light Transmission of Glass	88	
UV Blocked		
(100% Total Ultraviolet) - (UV Transmission of Glass with Film)	<u>100-1</u>	= 99%
100% Total Ultraviolet	100	

HEAT TRANSFER

**HIGH
TEMPERATURE
BODY**

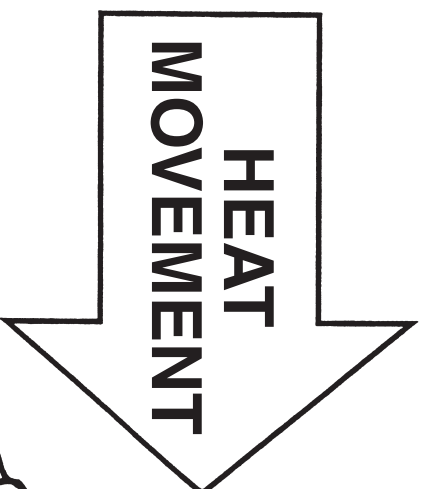
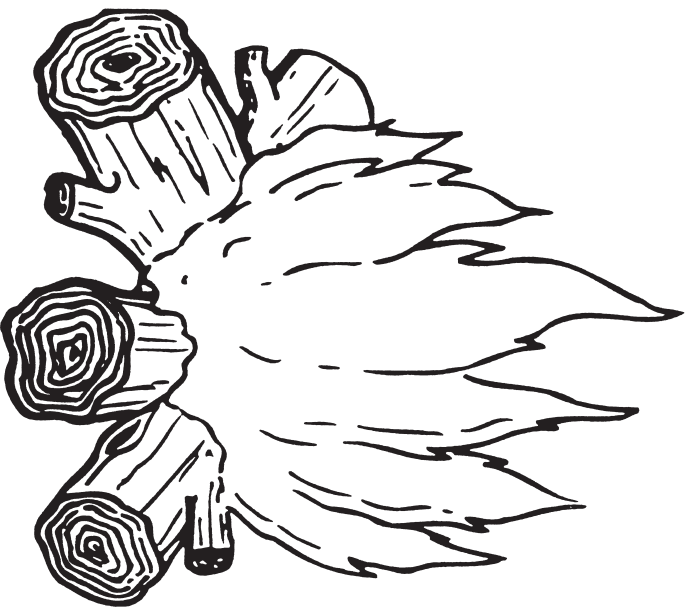

**LOW
TEMPERATURE
BODY**

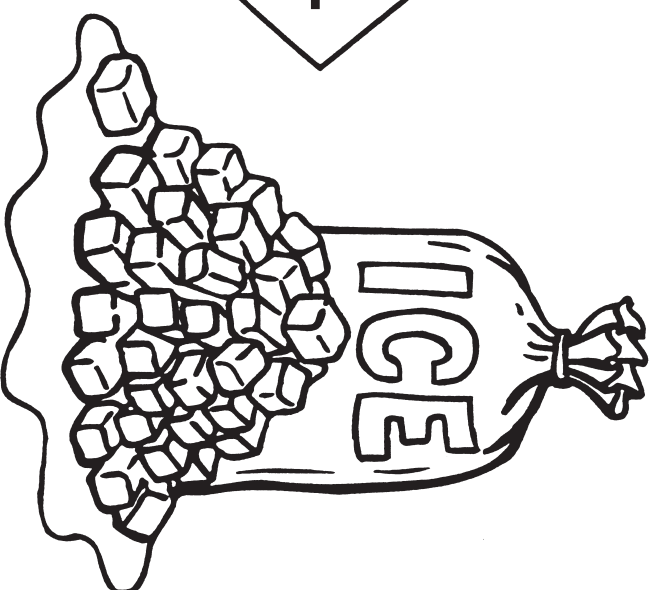

BTU

British Thermal Unit

The amount of heat required to raise the temperature of one pound of water one degree Fahrenheit.

1 BTU = 252 Calories (CAL)

1 BTU = 1054 Joules (J)

Methods of Heat Transfer

1. Radiation
2. Conduction
3. Convection

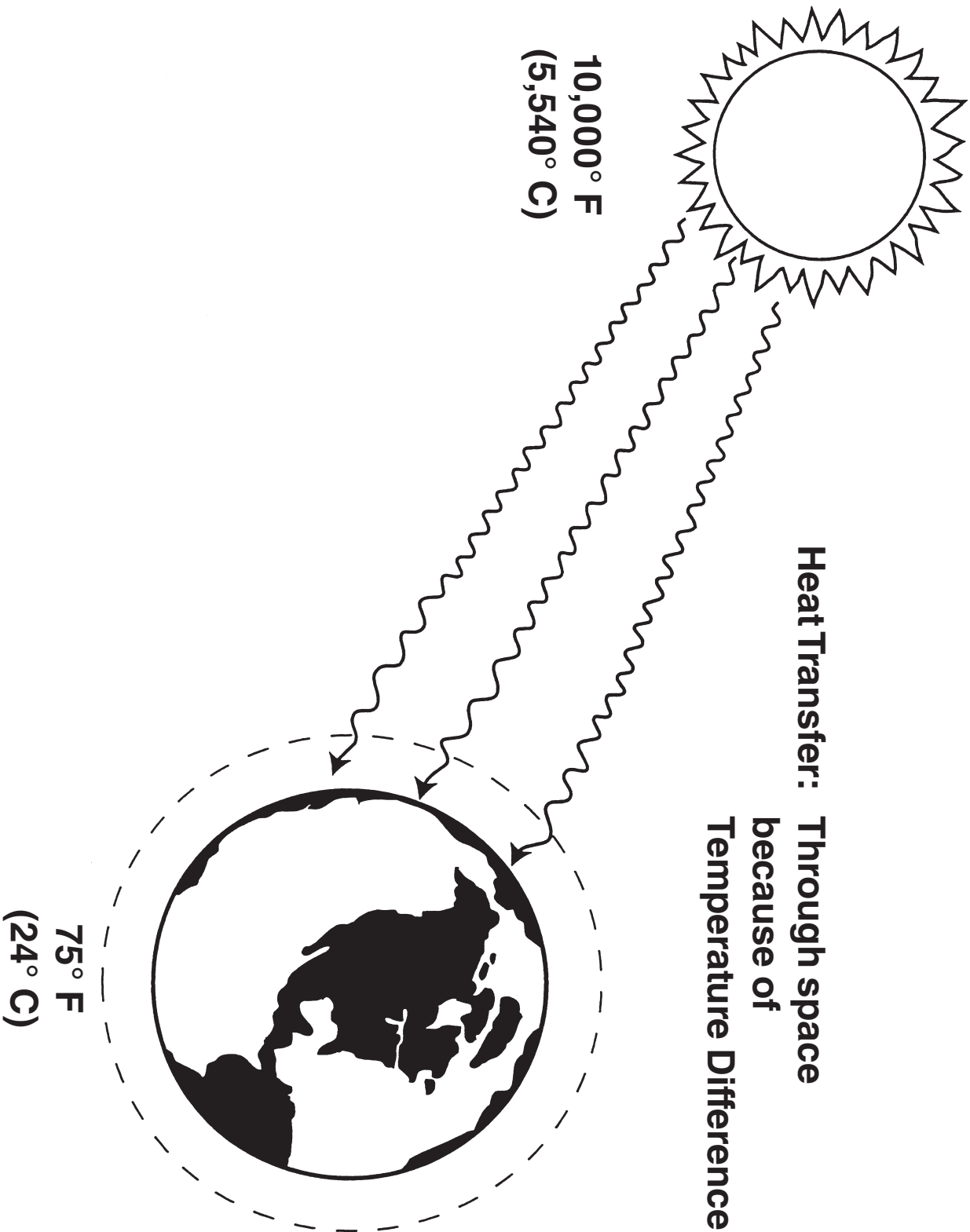

CONDUCTION

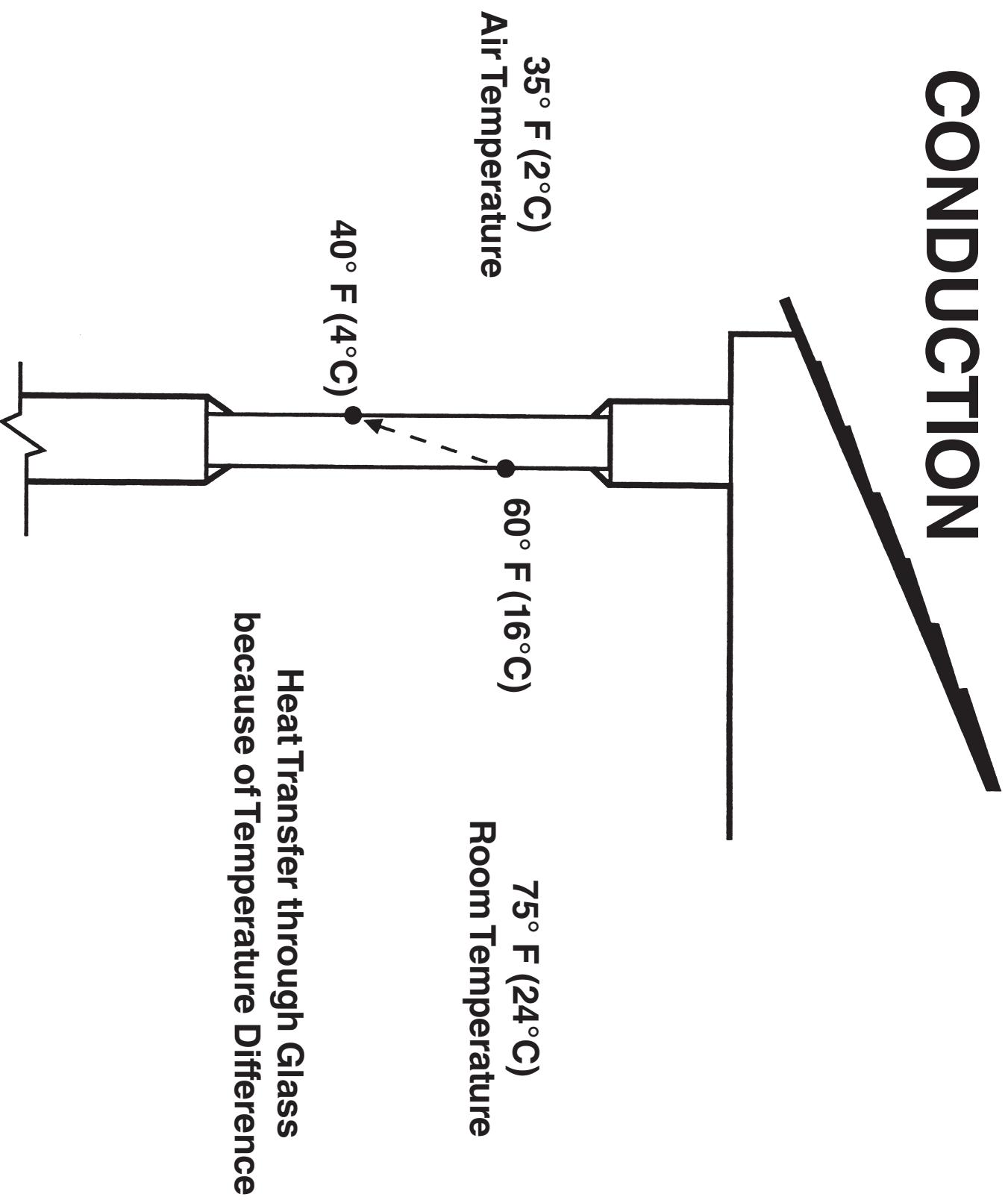

CONVECTION

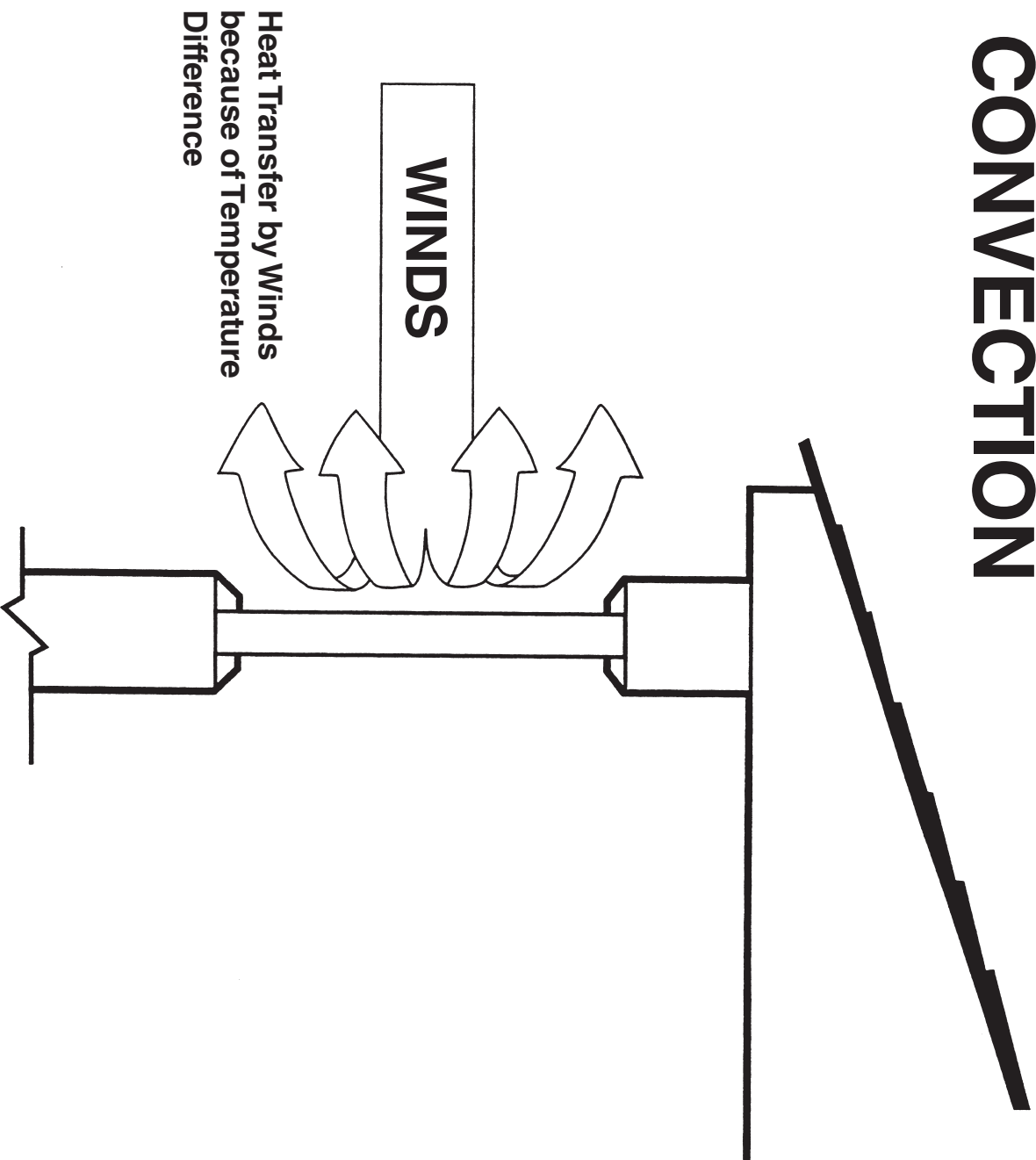

General Information

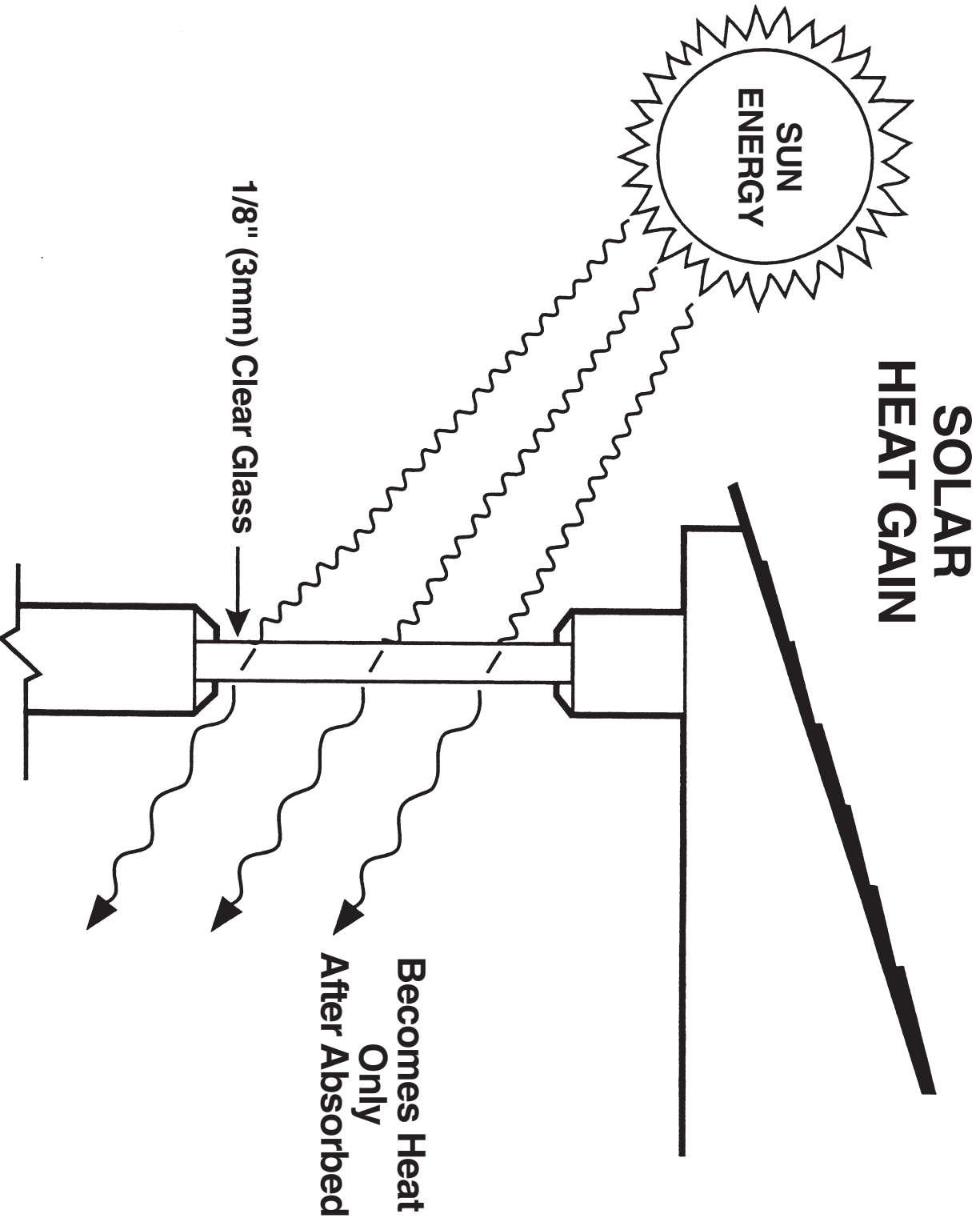

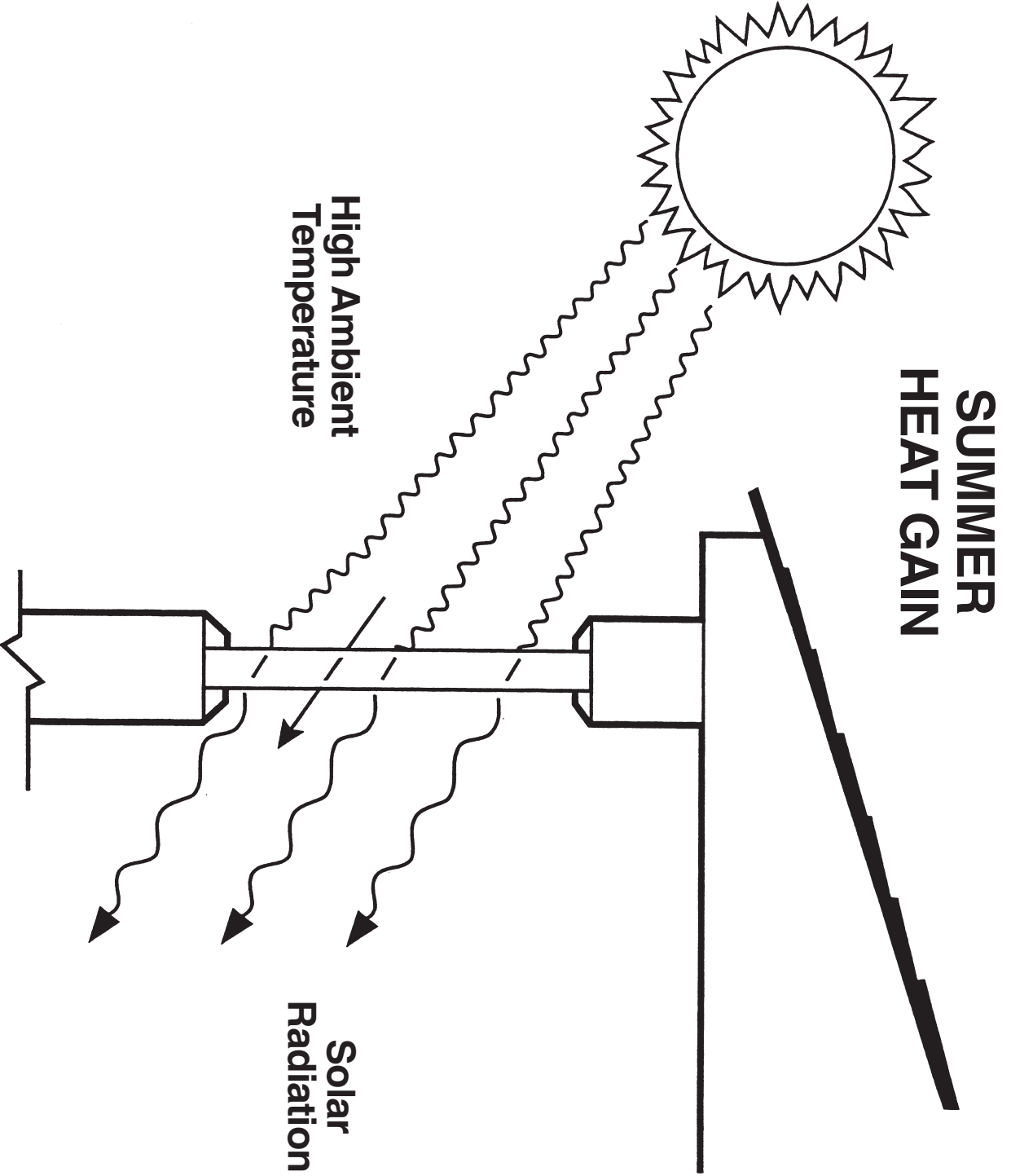

General Information

TON - HR

One Ton of Air Conditioning = 12,000 BTU/HOUR (3.52 kWh)

WINTER HEAT LOSS

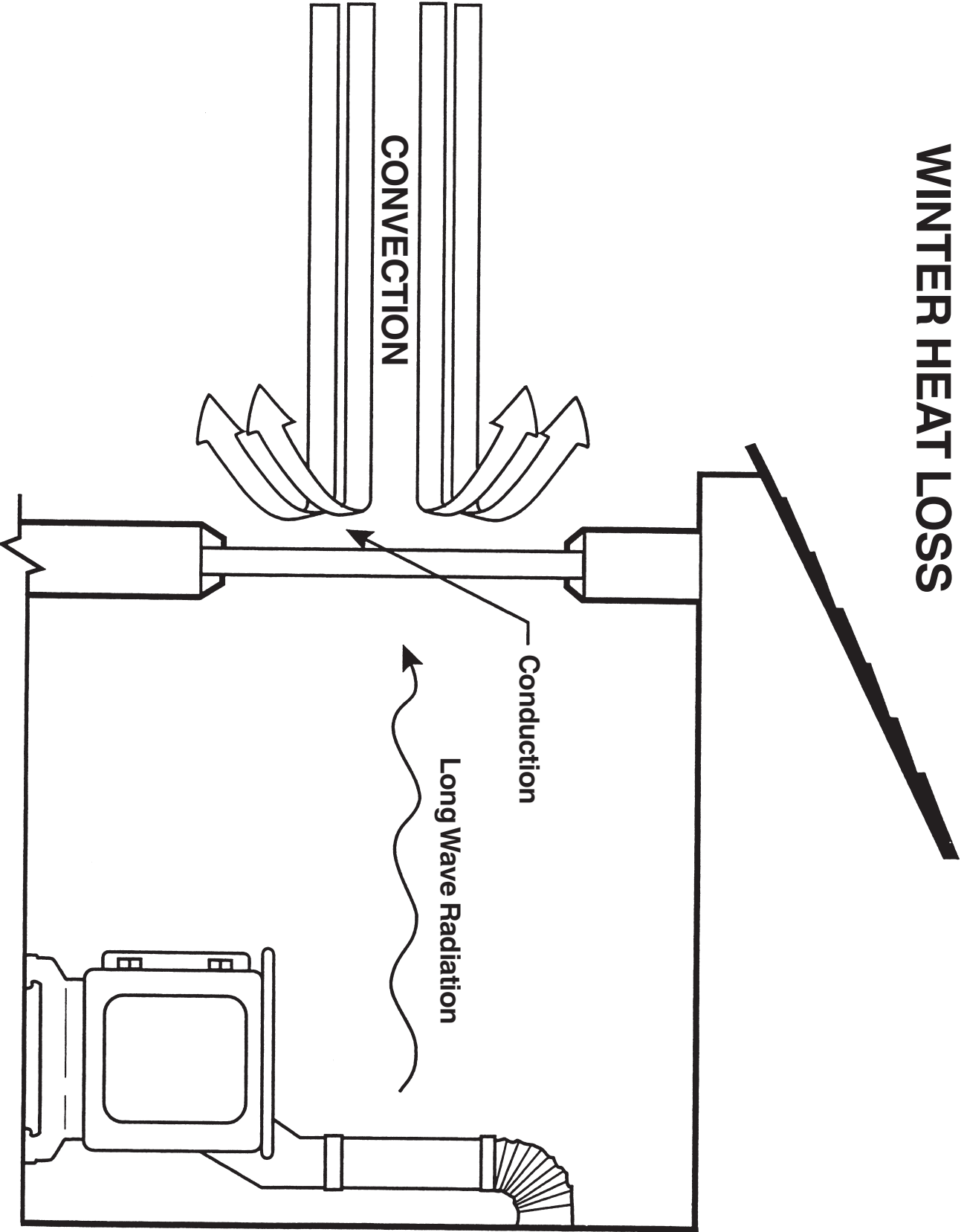

CONVECTION

Conduction

Long Wave Radiation

GENERAL BACKGROUND

SOLAR RADIATION VS. LONG WAVE RADIATION

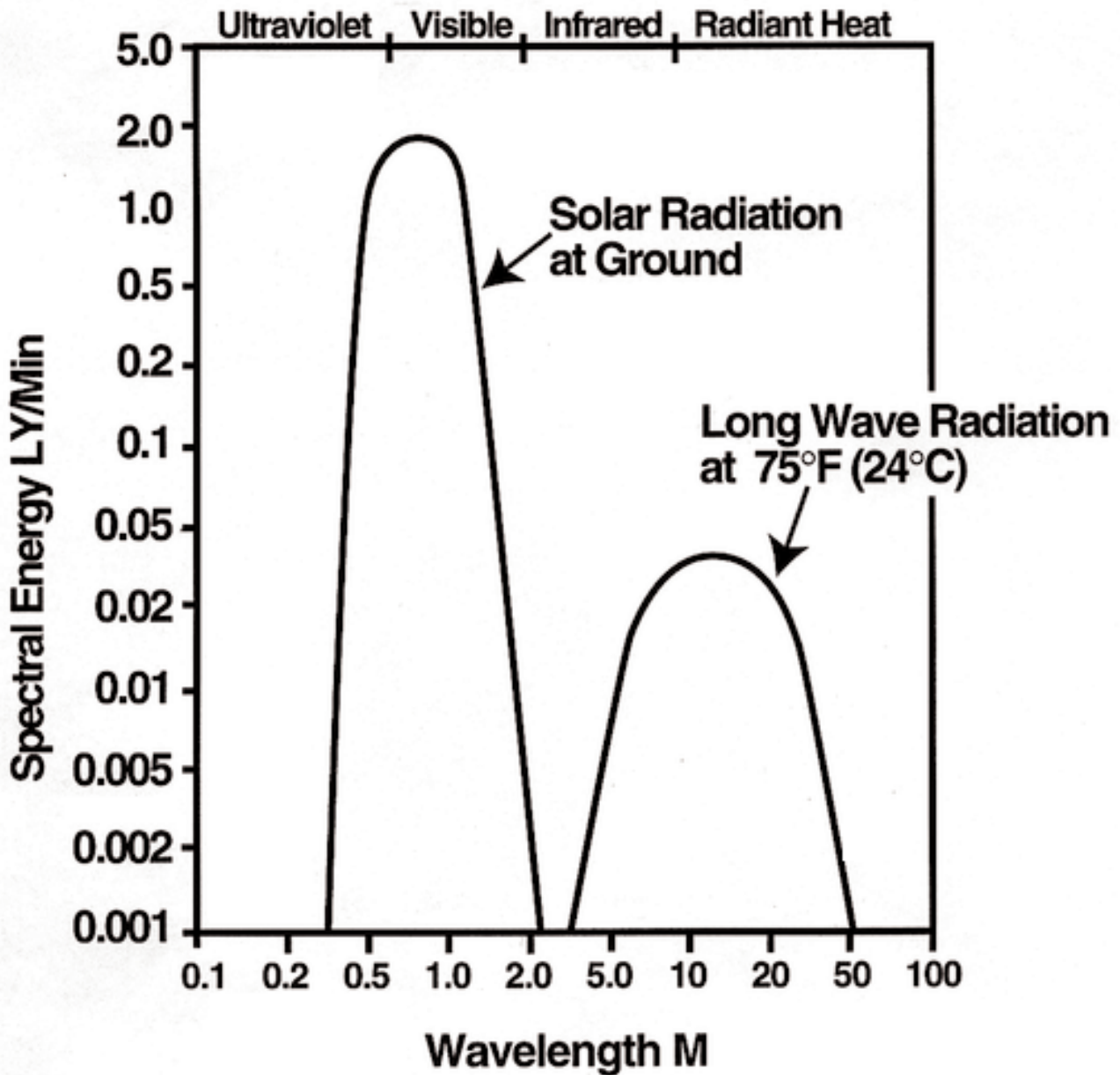

General Information

3M
Window Film
Top 20 Questions
(and Answers)

1. How do Scotchtint sun control films work?89

2. How do Scotchtint Plus All Season (LE) Films work?89

3. Why do commercial customers have Scotchtint film applied to their buildings?89

4. What is the typical energy pay back for Scotchtint window films?90

5. How is Scotchtint window film applied?90

6. How long does it take for Scotchtint window films to dry?90

7. Can I install Scotchtint window film myself?90

8. How do I clean my Scotchtint window film?90

9. How long does Scotchtint window film last?90

10. How do I remove the old film from my windows?91

11. What is the warranty for Scotchtint window film?91

12. Do Scotchtint window films cause glass to break?91

13. Do Scotchtint window films cause seal failure when applied to insulated (double-pane, Thermopane™) windows?91

14. Will Scotchtint window film stop my furnishings from fading?92

15. Does the Ultraviolet protection lose its effectiveness over time?92

16. How do Scotchshield Ultra Safety and Security Window films work?92

17. Are Scotchshield (Ultra) films hurricane-proof? Bullet-proof? Burglar-proof?92

18. Will Scotchshield (ultra) film keep my glass from breaking?93

19. Does 3M make Scotchtint and Scotchshield window films?93

20. How do I find the nearest authorized 3M Scotchtint dealer? Or, is XYZ Tinting a 3M Scotchtint dealer?93

General Information

1. How do Scotchtint sun control films work?

Scotchtint sun control films are designed to help reduce the amount of solar heat transmission through window glass by increasing the solar reflection (not necessarily visible reflection) and solar absorption through the glass.

Typical colored or dyed films work primarily through increased absorption. The color absorbs the solar energy at the glass, thus reducing the direct transmission into the room. These films only offer marginal performance when compared to reflective films.

Reflective films are films that have been precision coated with metals. These metalized films are designed to increase the solar energy reflection of the glass and some of the absorption. Scotchtint reflective films range from moderate to excellent in solar performance (heat gain reduction).

All Scotchtint sun control films are made to be transparent and optically clear. The ultraviolet protection in the adhesive system is there to protect the adhesive, the metals, the polyester film, and the abrasion resistant coating from UV degradation. This UV protection will also help protect what is behind the film (home and office furnishings), too.

Most Scotchtint window films are protected with our patented abrasion resistant coating for long term durability and maintained appearance.

2. How do Scotchtint Plus All Season (LE) Films work?

Scotchtint Plus All Season films, or Low E films work much in the same way as the sun control films except that they offer an increased performance against cold weather heat loss. The patented constructions of these films enable the metal coating to reflect more of the interior room heat back into the room where it is needed. This improves comfort by reducing potential draft feelings near the window, and may also save on fuel costs, especially in commercial buildings. The LE films are also protected with our abrasion resistant coating for long term durability and maintained appearance.

3. Why do commercial customers have Scotchtint film applied to their buildings?

- Improved tenant comfort
- Lower heating and cooling operating costs
- Lower utility demand costs
- Utility rebates
- Improved aesthetics, uniform appearance
- Improved safety and security
- Extended A/C equipment life
- Valued alternative to adding more A/C equipment

Most often, our commercial customers will purchase Scotchtint window films for tenant comfort and justify the purchase on energy cost savings.

4. What is the typical energy pay back for Scotchtint window films?

Simple pay backs will vary depending upon the amount of sunlit glass exposure, the type of film, the type of glass, cost of fuel, cost of application, and other variables. However, we have seen pay backs often range in the 2-5 year period, with some reported to be even less than 6 months.

5. How is Scotchtint window film applied?

Scotchtint films are professionally applied by skilled, well-trained authorized 3M Dealer personnel. Almost all of our films are designed to be applied to the inside of your glass.

The first step is to prepare the window area for the application; placing drop cloths on the floor protecting and/or moving furniture where necessary.

Next, the window glass is cleaned using simple cleaning solutions (often water and ammonia) and razor blade scrapers. Then the film is sprayed with a slip solution (detergent and water) for proper positioning, and applied to the window glass. Using a professional grade squeegee and following proper techniques, the application is completed by removing excess water, trimming the edges, and a final squeegee technique to dry the edges.

6. How long does it take for Scotchtint window films to dry?

We suggest allowing thirty days for the film to fully dry and cure. During this curing process, it is natural to have small water bubbles and/or a hazing milkiness appearance. These will disappear as the film dries; depending upon the film type and weather conditions, drying may take as much as 30 (or even 45) days, or as little as a few days. Once dried, Scotchtint films will look great and perform for many years to come.

7. Can I install Scotchtint window film myself?

No, Scotchtint window films require professional application; our authorized 3M™ Scotchtint™ window film Dealer/Applicators are thoroughly trained and experienced in performing high quality work. In this way, our customers will enjoy the benefits of Scotchtint window films and have the comfort of the 3M Scotchtint warranty.

8. How do I clean my Scotchtint window film?

After thirty (30) days, you may clean Scotchtint films using normal household cleaning solutions, including ammonia based products: e.g., Windex, and a soft, lint-free cloth or towel. You may also use a squeegee to clean the films. Abrasive products which would scratch or damage the film should not be used.

9. How long does Scotchtint window film last?

Scotchtint window films are made durable to last for many years; just how long may depend upon the type of film applied, type of glass it is applied to and the particular climate in which it is applied. Most applications last upwards of twelve to fifteen (12-15) years and beyond, and several applications are still performing after fifteen (15) years. All applications have a minimum warranty period of five (5) years (except exterior applications which are two (2) years), and several films carry a ten (10) year commercial warranty, and even a lifetime residential warranty.*

*(Lifetime for as long as original purchaser owns their home)

10. How do I remove the old film from my windows?

Scotchint window films are designed to bond the film to the window glass for many years. Yet when it is time to remove the film, removal can be performed by following a relatively simple process.

1. First, try to pull the film off by lifting and peeling the film from a corner. If removing the film is difficult, spray the film with a solution of detergent (Dawn™, Joy™) and water and cover with a plastic film (e.g., trash can liners work). Allow to soak for several hours or overnight. Now, try Step 1 again.
2. Next, the adhesive residue left on the glass can be sprayed with a sudsy ammonia and water solution and scraped with a four inch razor blade tool.

Unfortunately, other window films aren't necessarily designed for removal in their future. They can prove to be particularly difficult with removal, and may require more drastic measures.

11. What is the warranty for Scotchint window film?

Scotchint window films are warranted to maintain their solar properties without bubbling, peeling, cracking, or crazing. Many of our films are warranted against discoloration, too. (Those which do not use dyed polyesters). Should the product prove to be defective, 3M and the authorized Scotchint™ dealer will replace the film and provide the reapplication labor free of charge.

In addition, the 3M Scotchint window film warranty includes 60 months glass breakage coverage for all qualified applications. Should your glass break due to thermal shock, 3M will replace the glass (maximum \$500.00 per window) and the dealer will replace the film.

The length of the warranty is determined by film type and market (residential or commercial).

12. Do Scotchint window films cause glass to break?

No, Scotchint window films do not cause glass to break. However, we do understand that the application of Scotchint will increase the temperature of your sunlit glass which will increase the stress on the glass edges. The quality of those glass edges and several other factors (external shading, interior shading, glass history, type of film, size/shape of glass, indoor/outdoor temperature) all contribute to the potential risk of glass breakage.

3M's thirty (30) years of experience with applying Scotchint window films to different types of glass enables us to make proper film/glass recommendations and minimize the potential for glass breakage. In addition, we support these recommendations with our two year glass breakage warranty against thermal shock fracture. Should the glass break within two year of application, 3M will replace the glass (maximum \$500.00) per window, and the dealer will replace the film.

13. Do Scotchint window films cause seal failure when applied to insulated (double-pane, Thermopane™ >) windows?

No, Scotchint window films do not cause seal failure. We've been applying Scotchint films to insulated windows for over 25 years with several millions of square feet of film

applied to date.

When recommended films are applied to the inside pane of an insulated glass unit, there will be some absorption (except with clear safety films) of the sun's energy, which will increase the temperature of the glass pane. Some of this heat will transmit to the airspace, slightly raising the airspace temperature. However, even a 20 F degree increase (unusual for most films) will result in a less than 3% change in air pressure, whereas properly made units are designed and tested to withstand 22% changes in air pressure.

Risk of seal failure is greatly determined by the quality of workmanship and the quality of the materials that go into building the insulated glass units. The best guard against seal failure is to purchase well-made units from reputable window manufacturers that have solid experience and histories with insulated units.

14. Will Scotchtint window film stop my furnishings from fading?

Nothing stops fading. Scotchtint films are designed to help reduce the major causes of fading (Ultraviolet light, visible light, and solar heat), thus prolonging the life of your furnishings, perhaps as much as two to five times.

Keep in mind the article(s) to be protected; if they have a typical life of five (5) years then they may last ten (10) years to much longer depending on the performance of the film selected. However, if the typical life is only 2-3 weeks, then the expectation should be expressed in terms of months.

As a general rule of thumb, Ultraviolet (UV) is approximately 40% of the cause, visible light is about 25%, and heat about 25%. The remaining 10% can be attributed to humidity, pollutants, interior lights, dye anchorage, and more.

15. Does the Ultraviolet protection lose its effectiveness over time?

No, the Ultraviolet (UV) protection that we use in our proprietary adhesive system is indefinite. It does not lose its effectiveness over time. In fact, we tested an actual glass sample from The Dumbarton House, Washington, DC. This was a ten (10) year old application and the Ultraviolet transmission still measures <1%!

16. How do Scotchshield Ultra Safety and Security Window films work?

Scotchshield Ultra Safety and Security window films are designed to make glass shatter-resistant by hold the glass pieces together when broken.

Different from Scotchtint film, Scotchshield window films are made with thicker polyester and a much thicker, more aggressive adhesive system. The *Ultra* films are unique in the industry; they are built using a special micro-layered polyester technology which increases the films' tear resistance significantly. Pound for pound, the impact and tear resistance of Scotchshield Ultra films outperform all other films of similar thickness.

17. Are Scotchshield (Ultra) films hurricane-proof? Bullet-proof? Burglar-proof?

No, Ultra films are not hurricane-proof, earthquake-proof, bullet-proof, bomb-proof, nor burglar-proof. Again, they are designed to make the window glass more shatter-resistant.

In the event of a **wind storm**, these films may have significant safety and security value. They can reduce the risk of injury from flying shards of broken glass, and possibly help

prevent debris and water penetration through the window depending on the severity of the storm (and the type of glass, framing system, size and velocity of objects, and more).

In an **earthquake**, these films can reduce the risk of serious injury from flying shards of broken glass, and possibly prevent glass from falling out of a home or building. Again, much may depend upon the severity of the quake (and the type of glass, framing system, and more, too).

Bullets: these films are not designed to stop bullets.

3M Scotchshield films were originally developed due to the international concerns and needs for improved safety and security against **terrorist acts of bombings**. These films can significantly reduce the risk of serious injury from flying shards of glass due to blasts, however, much depends upon the severity of the blast and the proximity of the window glass to the blast (and glass type, framing system, and more too).

Scotchshield ultra films are a low-profile, high performance measure of security in the battle against ‘**smash and grab**’ crime. The tough, shatter-resistant qualities of the film can hold the window glass together even if a brick (or similar object) were actually to pass through the glass. The thief must now make a choice; continue to attack this window, try another window, or move on. Time is short, and often they move on. However, if they are determined to gain entry, they will get in. It is generally recommended that the property have proper alarm systems in addition to Scotchshield ultra window film.

18. Will Scotchshield (ultra) film keep my glass from breaking?

This is difficult to answer with any degree of certainty because it is difficult to test for this. Window glass varies in strength from piece to piece, and lot to lot. So, if a Scotchshield protected window were impacted, yet, failed to break, it would be difficult to determine if the glass alone, the film alone, or the film and glass together resisted the breakage.

When glass breaks, Scotchshield Ultra Film demonstrates it's best performance!

19. Does 3M™ make Scotchtint™ and Scotchshield™ window films?

This may seem a very odd question, however, there are some competitive dealers that wish to confuse our customers with the boldest and strangest of claims. So even odd and obvious, it bears a response.

In the thirty (30) years since we developed this business, there have been many imitators and impostors. However, there is only one company that has ever made Scotchtint™ and Scotchshield™ window films, and that, of course, is 3M. We offer the genuine article and back it with our genuine warranty.

20. How do I find the nearest authorized 3M™ Scotchtint™ window film dealer? Or, is XYZ Tinting a 3M Scotchtint window film dealer?

The simplest way is to contact 3M directly for the name of the nearest 3M Distributor 1-800-480-1704. We would be able to provide you with an up-to-date listing of the Authorized Scotchtint Dealer/Applicator in your area. They can confirm which businesses are Authorized 3M dealerships.

FACTS ABOUT FADING

What Causes Fading? “As A Rule Of Thumb”

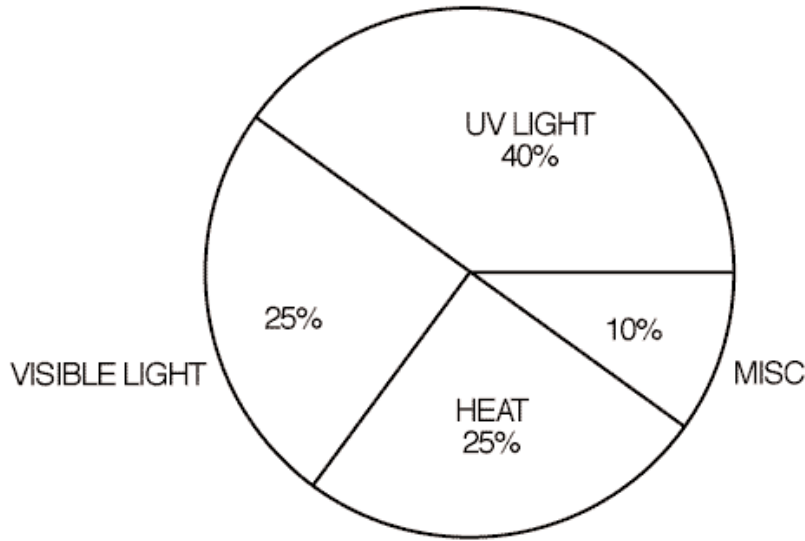

3M™ Scotchtint™ Films and 3M™ Scotchshield™ Films Do Not Stop Fading They Help Reduce Speed Of Fading

Approximate fade reduction with RE35NEARL

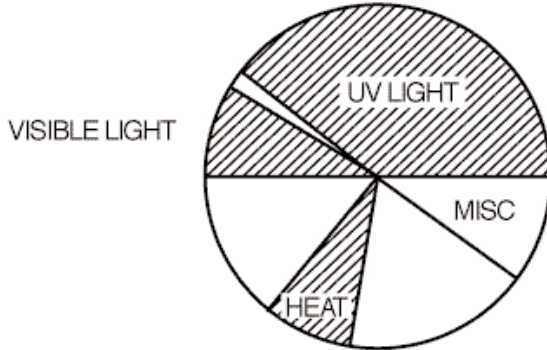

Approximate fade reduction with P-18ARL

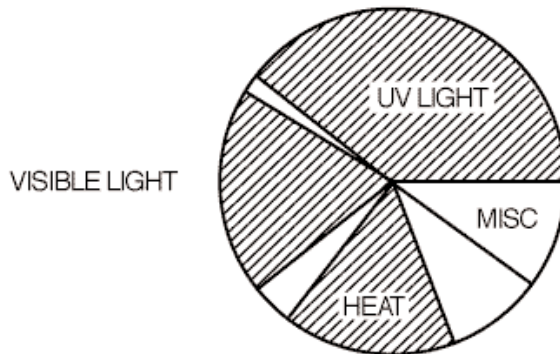

Shaded areas indicate approximate amount of fade reduction when applying the Scotchtint films mentioned above.

LONGEVITY

1. 3M Weathering Resource Center
 - a. Accelerated aging artificially
 - b. Tested in weatherometers simulating solar energy, humidity, heat, etc.
 - c. Tested for 2,000 hours = 5 - 6 years

2. Florida - Independent Laboratory
 - a. Natural aging
 - b. Exposed to outside environment - humidity, light, heat, etc.
 - c. Tested on racks at 45° angle to horizontal for maximum solar exposure
 - d. Tested for one year = 5 - 6 years

3. Arizona - Independent Laboratory
 - a. Natural aging
 - b. Exposed to outside environment - dry, light, heat, etc.
 - c. On racks with mirrors concentrating sun on test samples
 - d. Racks track sun - greater acceleration - approximately 10 times
 - e. Tested for six months = 5 - 6 years

STORAGE CONDITIONS

Recommended storage conditions are printed on the box. They are 70° F (21° C) and 40 - 50% relative humidity. Avoid extremes in storage conditions.

EMI

Background and Definitions

Test Results

BACKGROUND AND DEFINITIONS

Basic Background Information

1. Why are we involved with EMI Shielding?

- a. Customers have asked if our 3M™ Scotchtint™ films will block radio waves or microwaves
- b. Some of our current competitors claim that their products work for this application

2. What is EMC, EMI and EMIC?

a. EMC - Electromagnetic Compatibility

Electrical devices have EMC when the electrical noise generated by each device does not interfere with the normal performance of the other device

b. EMI - Electromagnetic Interference

EMI is said to exist when undesirable voltage or currents adversely affect the performance of a device

c. EMIC - Electromagnetic Interference Control

The process of making design changes or adjustments of signal or noise levels is called EMIC

3. What is EMI and EMIC?

- a. When electricity flows it generates electromagnetic waves
- b. The wavelength and frequency of the wave determines where these waves are classified in the Electromagnetic Spectrum
- c. EM waves can interfere with the performance of electronic devices
- d. All electronic devices generate EMI.
- e. Grounding or adding filters is an EMIC method.

4. Why is EMIC necessary?

- a. Protect electronic equipment from destructive outside interference such as:
 1. High power transmitters (radar, FM, etc.)
 2. Nuclear effects - electromagnetic pulse (EMP)
 3. Lighting
- b. Prevent interception of classified military or industrial information through espionage
- c. Protect electronic equipment from temporary equipment malfunctions

5. How is the EMI problem solved?

- a. EM waves (fields) are reduced (attenuated) through absorption or reflection by conductive surfaces (shields)
- b. The most effective shields are metallic and electrically conductive
- c. How well the shield attenuates the field is called its shielding effectiveness (SE)

TEST RESULTS

Shielding Effectiveness For 3M™ Films

Tested according to ASTM D 4935, “Standard Test Method for Measuring the Electromagnetic Shielding Effectiveness of Planar Materials.” This is a far field test measurement taken using a coaxial cell. The dynamic range indicates the maximum measurement capability of our test setup, in other words the response of a “perfect shield

Frequency

Product	30 MHz	100 MHz	300 MHz	1 GHz	2.5 GHz	4.5 GHz
LE30CUARL	30 dB	28 dB	28 dB	30 dB	31 dB	32 dB
LE20SIAR	25 dB	23 dB	23 dB	25 dB	26 dB	28 dB
RE50AMARL	35 dB	33 dB	32 dB	34 dB	35 dB	36 dB
LE35AMARL	37 dB	35 dB	34 dB	36 dB	36 dB	38 dB
P18ARL	24 dB	22 dB	22 dB	24 dB	26 dB	27 dB
RE15SIXL	24 dB	23 dB	23 dB	25 dB	26 dB	28 dB
RE35NEARL*	7 dB	7 dB	7 dB	7 dB	7 dB	8 dB
RE35AMARL	38 dB	35 dB	34 dB	36 dB	36 dB	38 dB

*Negligible shielding properties

EFFECTS ON HOUSE PLANTS

Effects On House Plants With 3M™ Scotchtint™ Film Applied On Glass

KNOWN FACTS

1. Growth and development requirements vary with different plants
2. Growth and development depend upon light, temperature range, exposure, humidity, CO2 levels, etc.
3. For sufficient growth, the wavelength of 400-700 nm is important for photosynthesis (greening process)
4. 700-850 nm range is required for the photomorphogenic process (flowering process)
5. Most greenhouses have artificial light to supplement natural light (day vs. night, summer vs. winter, cloudy vs. sunny)
6. UV is damaging to most green plants
7. Extreme temperature variations are detrimental to plant growth
8. Scotchtint film will help reduce solar heat gain, temperature buildup and moisture loss (Plants may require less water. Care should be taken not to drown plants from over watering)

WHAT TO DO WHEN IN QUESTION?

Contact a local horticulturist, local college or university extension office

- Provide type of plant(s)
- Provide percent reduction of visible light, UV and solar heat with specific Scotchtint film applied to glass

MANUFACTURING PROCESS

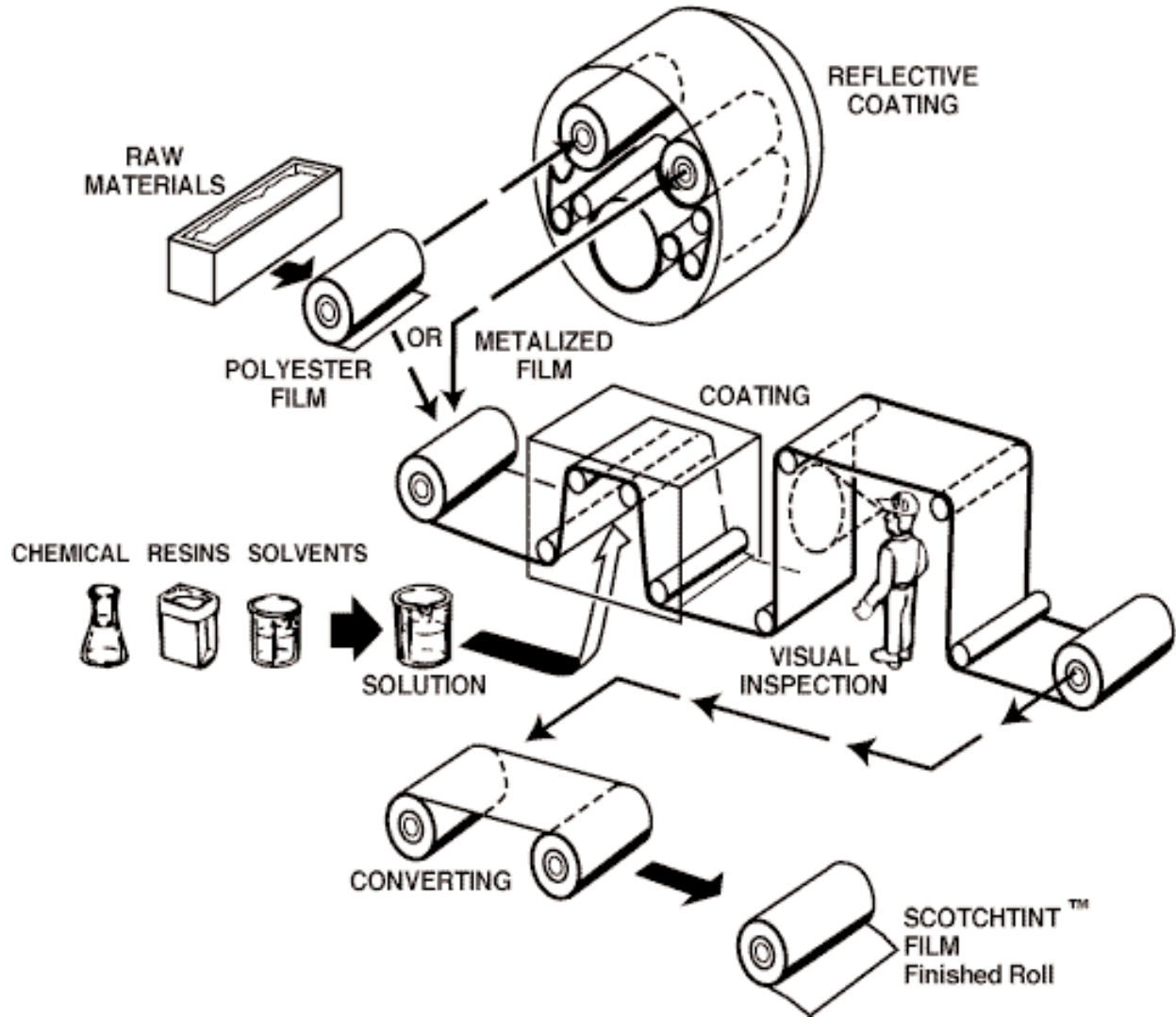

Glass Types and Thermal Stress

Glass Types

Primary Glass Products
Fabricated Glass Products

Thermal Stress
Edge Strength
Will Scotchtint Break My Glass?

Glass Checklist

Restrictions List
Breakage Warranty
Instructions
Sample Form
Expected Edge Stress

Glass Types

Primary Glass Products

Fabricated Glass Products

Thermal Stress

Edge Strength

Will Scotchtint Break My Glass?

PRIMARY GLASS PRODUCTS

FLOAT GLASS

The Float Glass Process accounts for over 90% of the flat glass presently produced in the United States. In this process, molten glass is poured continuously from a furnace onto a large bed of molten tin. The molten glass literally floats on the tin, spreading and seeking a controlled level in the same manner as water poured onto a smooth, flat surface.

In the controlled level seeking process, the molten glass is allowed to spread to width of 90" to 140", depending upon the furnace size and glass thickness being produced. The glass slowly solidifies as it travels over the molten tin. It then enters an annealing lehr where the cooling process continues under controlled conditions. After several hundred feet of travel through the lehr, it emerges as a continuous ribbon of glass at essentially room temperature. The product is now flat, fire-finished, and with virtually parallel surfaces.

CLEAR GLASS

Clear glass consists of silica sand with added alkaline salts such as lime potash and soda. It is colorless and has a visible light transmittance ranging from 75% to 92%, depending upon thickness. It constitutes the bulk of the flat glass that is used.

TINTED/HEAT ABSORBING GLASS

Tinted or Heat Absorbing Glass is made by adding various colorants to the normal, clear glass batch to create a desired color. The four colors available by the Float Process and Bronze, Gray, Green and Blue. Visible light transmittance will vary from 14% to 83%, depending upon color and thickness. The color density is a function of thickness, and increases as the thickness increases; visible light transmittance will decrease as thickness increases.

Tinting reduces the solar transmittance of glass, has little effect upon solar reflectance, hence increases solar absorption (heat). This explains why heat strengthening or tempering is sometimes required for the thicker tinted glasses. Adding a metallic coating also has the same effect on thinner glasses.

ASTM Specification C1036-85 separates Heat Absorbing and Tinted (light reducing) glasses into separate categories based upon the maximum solar energy transmittance, by glass thickness. Nevertheless, all tinted glass is heat absorbent, to one degree or another. The Bronze, Gray, Green and Blue tints produced by the Float Process are all classed as heat absorbent.

SHEET GLASS

The Sheet Glass Process accounts for a very small portion of U.S. production. Some imported sheet glass will continue to be used, mainly in thickness of 1/8" and less.

PLATE GLASS

Plate Glass, manufactured by the grinding and polishing process, is no longer produced in the United States, and words referring to it have been eliminated from the ASTM Specification C103685. It has been replaced by the float glass process.

ROLLED GLASS

The Rolled Glass Process consists of pouring molten glass from a furnace, then feeding it through rollers to produce the desired thickness. The glass ribbon then enters a lehr where the cooling continues under controlled conditions.

There are three general types of rolled glass: figured/patterned, wired and art/opalescent/cathedral glass.

FIGURED/PATTERNED GLASS

Figured/Patterned Glass is produced domestically by the continuous pour process in thickness of 1/8" to 7/32". A pattern etched on one or both of the rollers is reproduced on the glass. Colors are available but extremely limited.

This type of glass is frequently called "obscure" or "decorative" glass. The pattern diffuses detail of objects viewed through the glass, it does not obscure them. The degree of diffusion achieved is a function of the pattern and whether the pattern is on one or both sides.

Some patterns cannot be tempered for safety glazing use because of their depth.

WIRED GLASS

Wired Glass is produced on the same equipment as is Figured/Pattered glass. A welded wire netting or parallel wires are introduced into the molten glass just before entering the rolls, thus embedding the wire into the glass. Patterned wired glass has pattern on one or both sides, and is sometimes called "rough" wired glass. Polished wire glass is produced by grinding and polishing rolled wired glass blanks.

Tinted/Heat Absorbing wired glass is available only as an import. The heat absorbing characteristic in conjunction with the normally poor cut edges and the wire netting can cause a high rate of breakage from thermal stress, especially in non-vertical applications.

The major uses of wired glass is in institutional buildings and fire rated windows and doors. All wires must be completely embedded in the glass. Some misalignment of the wires may be noticeable, but this is not considered cause for rejection.

Wired glass cannot be tempered. From a windload standpoint, it is considered to be approximately 50% as strong as annealed glass of the same thickness.

The edges of wired glass should be sealed from water to prevent rusting of the embedded wires. This can be accomplished either by physically sealing the perimeter of the lite with a sealant or by glazing in such a manner that the glazing rabbet will always remain dry. The iron oxide molecule is larger than the iron molecule, so rusting of the wires will cause glass breakage.

Most Building Codes require that wired glass meet NFPA 80 or be classified by U.L. as fire resistant glazing when used in fire doors or windows.

Wire glass does not meet the requirements of CPSC 16CFR12301, hence cannot be used as a safety glazing material in situations governed by that law.

ART/OPALESCENT/CATHEDRAL GLASS

Colored translucent glass, often called art glass, opalescent glass, cathedral glass or stained glass, is also produced by the rolling process, but generally in small, batch type operations. There are usually variegated colors within each sheet produced and no two sheets will match for hue. Thickness will vary within a sheet as well as from sheet to sheet. The maximum thickness produced is usually 1/8”

When used as a glazing material, art glass should be glazed in the same manner as tinted/heat absorbing glass. Art glass cannot be tempered.

Because leaded windows and other applications of art glass are separate subject, details will not be covered in this manual.

FABRICATED GLASS PRODUCTS

INSULATING GLASS UNITS

Double insulating glass units consist of two panes of glass that enclose a hermetically sealed air space. The panes are held apart by a spacer around the entire perimeter. The spacer contains a moisture absorbent material called a desiccant that serves to keep the enclosed air free of visible moisture. The rubber-like material that produces the hermetic quality of the unit. Some manufacturers use non-curing sealant.

CERTIFICATION

The purpose of a certification program is to assure the user that the purchased product is a faithful replica of one that has successfully passed certain prescribed tests. Participants in a certification program must therefore,

- a) submit their products to independent testing laboratories for the prescribed tests
- b) agree to periodic, unannounced inspection of their regular production by an independent agency to insure that actual production employs the same materials and techniques as the tested specimen.

For insulating glass manufacturers there are two competing certification programs available. One is conducted by Associated Laboratories, Inc. (ALI), which also conducts a companion certification predominantly window and door manufacturers who fabricate insulating glass for use in their own products. The second program, the Insulating Glass Certification Council (IGCC), is an independent, non profit organization whose management is vested in a Board of Governors made up equally of industry and public interest members. All IGCC meetings are open to the public.

Further information can be obtained by writing or telephoning :

Insulating Glass Certification	AND	Associated Laboratories, Inc
Route 11 Industrial Park		P.O. Box 15705
Cortland, New York 13045		1323 Wall Street
607-753-6711		Dallas, Texas 75215

DISTORTION

The air (or gas) sealed within an insulating glass unit will respond to the Gas Laws of Physics from the moment the unit is sealed. These laws govern the volume of gas as related to various temperature and pressure conditions. As the sealed-in air is heated or cooled, it expands or contracts. As the barometric pressure falls or rises, it likewise expands or contracts. This causes the two panes to bow away from or toward each other. They will be in virtually constant motion, hence seldom ever parallel (flat). When the glass is in a reflecting mode, the objects reflected will appear distorted. There is no known method by which precisely the same internal temperature and barometric pressure can be simultaneously achieved for each and every insulating unit on a specific project and still have the advantages of a sealed unit.

RETROFIT

Several systems have been developed to convert single glass into insulating glass in existing buildings. These systems involve cleaning the interior of the existing glass, applying a desiccated spacer, a second (new) pane of glass and a perimeter sealant. This generally works best on fixed (non-operable) windows. Optimum performance is generally achieved by using reflective glass. Since every project is custom, warranties can vary as can capabilities of insulator since this is field, rather than factory assembly.

WARRANTIES

Since no two insulating glass manufacturers use the same combination of components and fabrication techniques, no two warranties are alike. Warranties usually require adherence to certain installation procedures or techniques and exclude glass breakage and the replacement glazing labor.

REFLECTIVE GLASS

Reflective glass is a clear or tinted glass coated with an extremely thin layer of metal or metallic oxide. The coatings are thin by design; otherwise they could not transmit light. Dependent upon the desired level to visible light transmission, the coating thickness is generally in the range of .000001" to .000004".

Installed in a building, reflective glass imparts a mirror-like appearance to the exterior under most daytime conditions. It reduces heat gain and glare from the exterior and allows visible light transmission to the interior. The major attributes of reflective glass are

- a. **Aesthetic Appeal:** The various silver, copper, golden and earthtone reflective coatings, when combined with clear, bronze, gray, green or blue tinted float glass, allow the architect more flexibility in exterior design than with uncoated glass types alone.
- b. **Energy Savings:** Through its ability to reflect and absorb radiant solar heat, reflective glass will substantially reduce interior solar heat gain. The added cost of reflective glass will generally be offset by the size and cost reduction in the heating and cooling system.
- c. **Occupant Comfort:** Occupant comfort is improved when heat gain/loss differentials between sunny and shaded elevations are substantially reduced. Interior temperature variations are thus less and easier to control.

METHOD OF MANUFACTURE

There are three methods of coating deposition used in the manufacture of reflective glass:

- a. **Wet Chemical Deposition:** This is simply the precipitation of a metal from a chemical solution by a reagent. The reaction occurs uniformly in a thin film on a horizon piece of glass instead of in a laboratory test tube. The film thickness is closely controlled to produce a desired level of light transmission. Coatings produced by this method are generally fragile, and must be immediately protected, usually by incorporating into an insulation glass or laminated glass product.

- b. **Vacuum Deposition:** This method involves a large vacuum chamber, vacuum pressures, an inert gas atmosphere and electrical energy. The electrical energy imparts a negative charge to the atoms of inert gas. The vacuum pressure, which is on the order of .0006 to .000006 psi (compared to 14.7 psi, normal atmospheric pressure), allows the negatively charged gas atoms to move freely at a high velocity. When they strike a metal cathode, atoms of the metal are dislodged, also at a high velocity. The metal atoms then impinge upon the glass substrate, creating the thin, metallic coating. Coating hardness and adhesion is a function of the metal or alloy used and of the particle speed at impact. Many vacuum deposited coated glasses can be used monolithically; or can be readily shipped to another location to be fabricated into laminated or insulating glass product.

Coated glasses produced by wet chemical or vacuum deposition methods cannot be tempered or heat strengthened after coating since this would destroy the coating. When used on a tinted glass substrate, tempering or heat strengthening is required because the reflective coating increases the solar absorption. Some coatings make clear glass so highly absorbent that the need for heat strengthening or tempering should be investigated prior to specification and purchase. A good rule of thumb is to investigate the need to heat treat any glass where the absorption of radiant solar energy is greater than 50%.

- c. **Pyrolitic Deposition:** This process applies a metallic oxide coating to hot glass (usually tinted). Pyrolitic deposition can be accomplished in a properly equipped heat strengthening oven, or on a float glass line near the hot end of thelehr. The metallic oxide is literally impregnated into the soft, cherry-red surface of the glass. Annealed glass with a pyrolitic coating side to the weather (to the outdoors). Since the radiant solar energy is substantially rejected by the coating before it enters the glass substrate, heat strengthening or tempering may not be required in many instances where it would be required for other types of reflective glass.

PERFORMANCE

Another way to classify reflective coatings is by the degree to which they reject radiant solar energy. The coatings created by wet chemical or vacuum deposition are usually of higher performance (i.e., have lower shading coefficients) than the pyrolitically deposited coatings of equivalent visible light transmission.

Wet chemical or vacuum deposited coatings have a lower shading coefficient when installed on the second (2nd) surface (vs. the 3rd surface) of an insulating glass unit. Pyrolitic coated glass has the lowest shading coefficient when installed on the 1st surface.

SPECIFICATION

All reflective glasses of the same general color and light transmission are not alike in reflectance level and other solar-optical properties, shading coefficient or U-value. The typical performance specification should state the primary type of glass, desired color of coating and maximum values of light transmission, shading coefficient and winter and summer U-values. Any alternate bids for glass having different values should have a companion alternate in the mechanical specifications if those glass values are sufficiently

different as to affect the size (larger or smaller) of the mechanical system.

The specifications should include a provision for construction of a full size mock-up incorporating the reflective glass and metal, for viewing and approval by the architect and owner. The mock-up should be located at the job site, thus giving a preview of the reflective qualities, distortions, etc., under real life conditions.

The pinholes, streaking and molting are generally process defects. The various coated glass manufacturers generally publish their criteria for coating quality or will supply their criteria upon request.

Monolithic coated glass, whether simply shipped to an insulating glass fabricator or to a jobsite for use “as-is” may be vulnerable to scuff or rub marks generated during shipment.

The monolithically glazed, coated glass may also be subject to scuffs, rubs, cup marks and scratches during and after glazing as well as by building occupants who do not realize that the coating is softer than the glass itself. Glass so used should be handled with greater-than-normal care by the glaziers and protected from the other trades, after glazing, by hanging a clear plastic sheet several inches inboard from the glass.

Anything that scratches glass will scratch a pyrolitic coating; vacuum coatings are not as hard as glass, hence more susceptible to damage.

LOW EMISSIVITY GLASS

The reflective glass heretofore discussed reflects the solar spectrum, that part of the heat spectrum in the 300 to 2100 millemicron range of wavelengths. Low emissivity coatings (low E) reflect that part of the heat spectrum above 3000 millemicrons wavelength that is called “sensible heat.” The heat from hot water or steam radiators and the heat from hot air ducts from a furnace are typical examples of this kind of heat.

These coatings have high visible light transmission. In fact, they are nearly invisible on the glass.

The visible light transmission is typically about 20 percentage points below that of an equivalent uncoated glass.

The major attribute of low E insulating units is their sensible heat reflecting character which is apparent from their low “u” values. In northern climates they admit winter sun while reflecting sensible indoor heat back into the building, when both lites are clear glass. In souther climates they reduce glare while reflecting the outdoor heat-of-the-day back out in summer with outboard lite bronze.

Low E coatings are applied to glass by vacuum processes and by pyrolitic processes.

TEMPERED GLASS

Tempered glass is fabricated by subjecting annealed glass to as special heat-treating process. The most commonly used process is to heat the glass uniformly to approximately 1150°, then rapidly cool it by blowing air uniformly onto both surfaces simultaneously. The cooling process locks the outer surfaces of the glass in a state of high compression and the central portion, or core, in compensating tension.,

The color, clarity, chemical composition and light transmission characteristics remain unchanged. Likewise, compression strength, hardness, specific gravity, expansion

coefficient, softening point, thermal conductivity, thermal transmittance and stiffness are unchanged. The only physical property that changes is tensile or bending strength. Under uniform loading, tempered glass is about four times stronger than annealed glass of the same size and thickness, thus is more resistant to thermally induced stresses, cyclic windloading and hail stone impacts.

When broken, tempered glass breaks into a multitude of small fragments of more-or-less cubical shape. Therefore, it qualifies as a safety glazing material under the criteria of Federal Standard 16 CFR 1201 and the American National Standards Institute (ANSI) Z97.1-1984, when so labeled and certified.

Spots or blotches may, at times, be visible on tempered glass, especially when viewed through polarizing lenses or in certain types of reflected light. The intensity will vary with lighting conditions and viewing angle. This is caused by the strain pattern induced during the cooling stage, and is not inherently a cause for rejection.

PRODUCTION

There are two basic methods for producing air quenched tempered glass. In one method the glass moves through the furnace and quench hung on tongs in a vertical position; in the other it moves on rollers of stainless steel or high strength ceramic, in a horizontal position.

Each method produces some degree of bow and warp, which is an inherent characteristic of all tempered glass. Tong-held glass may exhibit a long arc or “S” curve plus some minor distortion at the tong points. Horizontally tempered glass will have characteristic waves or corrugations caused by the support rollers.

LIMITATIONS

Recommended maximum service temperature for tempered glass is approximately 500° F. Tempered glass, although four times stronger than annealed glass, should not be selected to meet a given design wind load simply because annealed glass of the same thickness will not so meet. The stiffness of annealed glass and tempered glass is the same. Excessive deflection can cause glazing sealant failure, glass breakage by contact of an edge or corner with the framing and occupant discomfort.

Some deep patterns of rolled glass cannot be tempered or, if tempered, will not break in the manner prescribed by 16 CFR 1201 or ANSI Z97.1-1984.

Tempered glass cannot be cut, drilled or edged. It should not be sand-blasted or acid etched after tempering.

Wired glass cannot be tempered.

HEAT STRENGTHENED GLASS

Heat strengthened glass is fabricated by a process similar to that for tempered glass. Some equipment can produce both. The glass is heated to approximately 1100°F and the cooling process is slower than for tempered glass. The strength developed is about twice that of annealed glass.

Bow and warp generally are less evident to the eye than in tempered glass. Heat strengthened glass, compared to annealed glass, has greater resistance to solar-induced thermal stresses, cyclic windloading and hailstones.

Heat strengthened glass does NOT meet the criteria for safety glazing materials under 16 CFR 1201 or ANSI Z97.1-1984. The break pattern is similar to that of annealed glass, hence it tends to remain in the opening when broken.

SPANDREL GLASS

Spandrel glass panels are heat strengthened or tempered glasses with a ceramic frit color permanently fused to one of the surfaces. Glass in spandrel areas is not subject to corrosion as are some other spandrel materials. Pleasing esthetics and economies can be obtained using a single framing system for an entire wall.

Glass spandrel panels can also save energy when insulation is placed behind them. The insulation can be adhered directly to the glass or spaced 1/2" to 1" away.

When specifications require greater assurance that broken glass will remain in the opening, an open weave glass fiber cloth or a special tape can be adhered to the back of the spandrel panel. Some building codes require this. Test performance requirements can be found in Section 7.12 of ASTM C1048-85.

Scattered pinholes, screen marks and small opaque particles are permissible in the ceramic coating. Spandrel glass should not be used in areas subject to being viewed in transmission.

Reflective glass spandrels need to be rendered opaque to prevent read-through of the building structure under certain light conditions. In order of effectiveness, the following methods are suggested:

- a. A reflective insulating glass unit with a dark gray or black frit on one of the surfaces of the inboard lite. Insulation can be attached directly to, or applied against, the unit.
- b. Mount dark gray or black rigid insulation a minimum of 1" inboard from the monolithic reflective spandrel glass, preferably 2" or more from the glass. The air space between glass and insulation should be well weeped to the exterior to avoid condensation and potential staining.
- c. Adhere a black polyester, fiberglass, or other type of film to the inboard face of the monolithic reflective spandrel glass. The adhesive must be thoroughly tested, insulation must be spaced back from the film at least 1", preferably 2". The space must be well vented to avoid heat build-up that might cause problems with the film or the adhesive.

NOTE: All glass in spandrel areas should be heat strengthened or tempered.

LAMINATED GLASS

Laminated glass consists of two or more plies of glass interleaved with clear or tinted polyvinyl butyl (PF). The application of heat and pressure bonds the glass and plastic interlayer into one unit.

When laminated glass is fractured, the particles of glass tend to adhere to the plastic, affording protection against flying or falling particles. Some combinations of glass and plastic thicknesses do qualify as safety glazing materials under the criteria of ANSI Z97.1-1984 and CPSC 16 CFR 1201. From a windload standpoint, laminated glass is generally considered to be approximately 60% as strong as annealed glass of the same total thickness. Recent studies, as yet unpublished, indicate that laminated glass may be

virtually as strong as monolithic glass of the same thickness at normal temperatures, when subjected to wind loads. Additional research is in progress.

Laminates of glass and polycarbonates are available for special uses involving resistance to impacts of large magnitude.

Laminated glass can be made in many combinations of clear, tinted or reflective glass, annealed, heat strengthened or tempered, with PF ranging from .015" to .090" or more, dependent upon desired usage. Some of the most common architectural uses are for safety glazing, burglar resistance, bullet resistance, sound transmission reduction, sloped glazing and space enclosures.

A relatively new process, called resin laminating, is finding use in the laminating of curved glass and other special short-run applications. The process requires that the two lites of glass be spaced apart the desired dimension, such as 0.030 or 0.060, and the perimeter dammed on three sides. The assembly is stood vertically and a liquid mixture of chemicals is poured into the space between the lites and allowed to cure at room temperature from two to ten hours before it is ready for use.

MIRRORS

Most mirrors are manufactured by the wet chemical deposition method, although a few, for specialized use, are made by vacuum deposition. This processes are described under the Reflective Glass Section. There is a wide range of thicknesses, qualities and sizes available with annealed glass.

Safety mirrors are available to meet various laws and building codes. A mirror made from tempered glass will have the inherent distortion from the tempering process hence cannot have the same quality in reflection as laminated one made from mirror quality annealed float glass.

Transparent, or two-way mirrors, are designed to allow vision through from one direction while presenting a mirror appearance from the opposite side. Their major application is to permit undetected observation for study or surveillance in places such as prisons, gambling casinos and psychiatric treatment centers. A difference in lighting level is necessary; in the room to be studied the lighting level should be at least five times greater than the lighting level in the observation room; ten times greater is even more effective. Two way mirrors are not intended for use in exterior walls.

THERMAL STRESS

1. All glass absorbs energy when exposed to solar radiation
2. Tinted glass absorbs more than clear glass
3. Occurs when there is a temperature differential between center of glass and shaded edges
4. The ability of the glass not to break is determined by its edge strength

GLASS EDGE STRENGTH

1. Glass is made to withstand from between 3000 to 5000 psi (210 to 350 kg/cm) of edge stress
2. When edge stress exceeds edge strength, breakage occurs
3. Edge strength depends on glass size, thickness, how it is cut, and treatment of edge by glazier
4. A straight clean edge is the strongest
5. Damaged edges can reduce edge strength by up to 50%

Will 3M™ Scotchtint™ Film Break My Glass?

State The Facts When Answering

1. Partial shading patterns from overhangs or extensions
2. Tight fitting drapes or blinds
3. Painted signs, decal's or labels on glass
4. Heating and cooling vents directed at glass

Glass Checklist

Restrictions List

Breakage Warranty

Instructions

Sample Form

Expected Edge Stress Report

3M Window Film Restricted Information

Restricted Film and Glass Combinations

Film Type	Description	Single Pane Clear or Tinted	Double Pane Glass Clear/Clear or Tinted/Clear
PR40	Prestige Series		Conditional
AF15, AF30	Affinity Series		Restricted
RE20NEARL	Neutral Series		Restricted
CS5, CS20	Color Stable	Restricted	No Coverage*
BC10, BC20	Black Chrome	Restricted	No Coverage*
BC35, BC40	Black Chrome		Restricted
FX ST5	FX Series	Restricted	Restricted
FX ST20	FX Series		Restricted
FX HP5, HP20	FX Series	Restricted	No Coverage*
FX HP30, HP35	FX Series		Restricted

* - Warranty coverage is available for tempered glass.

Conditional Situation (Prestige Series – PR 40)

1. Glass checklist is not needed if there are no blinds or drapes. Must perform glass checklist if blinds or drapes are present.

Restricted Situations (All Window Films)

1. Single pane glass larger than 100 square feet (9.3 square meters).
2. Double pane glass larger than 40 square feet (3.7 square meters).
3. Clear glass thicker than 3/8 inch (9.5mm).
4. Tinted glass thicker than 1/4 inch (6mm).
5. Architectural shading from exterior overhangs, extensions, columns, pillars, etc.
6. Window framing systems of concrete, solid aluminum or solid steel.
7. Glass where sealant or glazing compound has hardened.
8. Buildings with more than 1% previous glass breakage or problems over the last two (2) years.
9. Reflective glass.
10. Laminated glass in single pane or double pane.
11. Window where frame is damaged.
12. Architecturally odd-shaped windows (half moons, cathedral, etc.) larger than 20 square feet.

~~NO COVERAGE - DO NOT SUBMIT GLASS CHECKLIST FORM~~ FOR THE FOLLOWING - No Glass Breakage Warranty

1. Wired, textured or patterned glass.
2. Triple pane glass or double pane glass in conjunction with a suspended film.
3. Partial applications of film to glass.
4. Applications of more than one tinted or reflective film to glass.
5. Visibly brittle, chipped, cracked or otherwise damaged glass.
6. Glass blocks.

3M™ Glass Breakage Warranty

1. **Does Not** apply to restricted film/glass combinations or situations without prior approval
2. Prior Approval requires submitting glass checklist form to 3M
3. 3M will calculate expected edge stress and determine if application is recommended
4. Copy of prior approval must be attached to warranty.
5. Only applicable in continental U.S.
6. Covers glass failure caused only by thermal stress

INSTRUCTIONS FOR COMPLETING GLASS CHECKLIST FORM

Customer-Dealer Information Section

Complete the **contact information** for both the **customer** and **dealer**. This information is used on the report cover, and is helpful if any questions about the project are encountered while creating the report.

Building Information Section

1. Indicate the appropriate **glass type**.
2. If the window is **single pane** indicate if the glass is **Annealed, Laminated, or Tempered** (you must choose one).
2. If the window is **double pane** indicate if the glass is **Annealed, Laminated, or Tempered** for the interior and the exterior panes.
3. Provide the **glass height and width** in inches (mm).
4. List the proposed **Scotchint™ Window Film type(s)**.
5. If the window is **single pane** provide the **glass thickness** in inches (mm).
6. If the window is **double pane** provide the **glass thickness** in inches (mm) for both the interior pane and the exterior pane.
7. Indicate the **number of windows** in the building.
8. Provide the **building age** in years.
9. Has the building experienced **glass breakage in the past** (check either yes or no)? If there has been glass breakage what is the **percent** of the windows that break **each year**.

Indoor Shading Section

1. Indicate the type of indoor shading.
2. If **drapes** are used specify the **color** and the **weave** type.
3. If blinds are used specify the **color**.
4. Determine if the indoor shading is **ventilated** or **non-ventilated** by using the diagram below.
5. Indicate the **space between the glass and the indoor shading**.

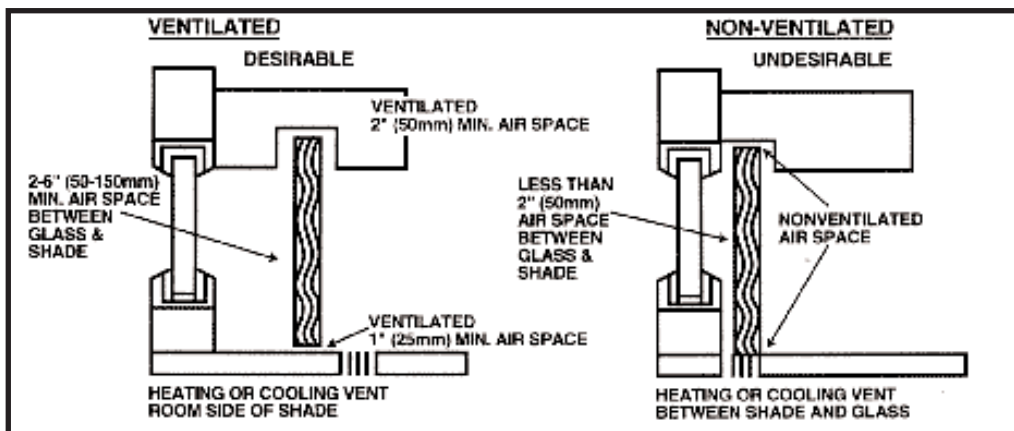

Outdoor Shading Section

1. Circle the **outdoor shading pattern** that indicates the most common shading pattern of the glass in this building.
2. If there is no shading pattern check the **None** box

Window Framing Section

1. Select the **framing system** used in the window from the choices shown below.
2. Specify the **sealant type** (i.e., rubber, neoprene, etc.).
3. Indicate the **condition of the sealant**.
4. indicate the **condition of the frame**.
5. Indicate the **outdoor glazing stop color**.
6. Determine if there is an **indoor structural pocket** present (see drawing below).

STRUCTURAL RUBBER GASKET

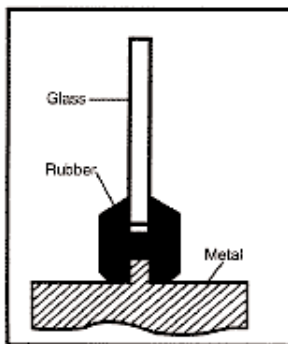

CONCRETE

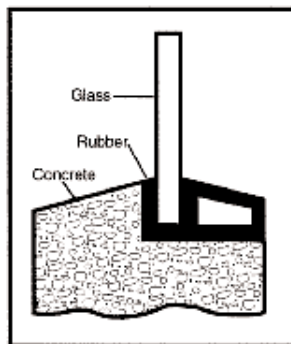

ALUMINUM OR STEEL TUBULAR THICK

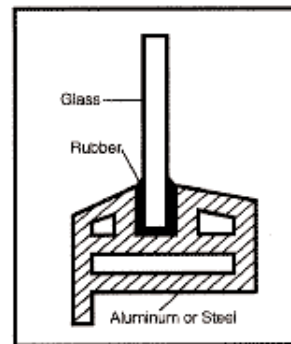

ALUMINUM OR STEEL TUBULAR THIN

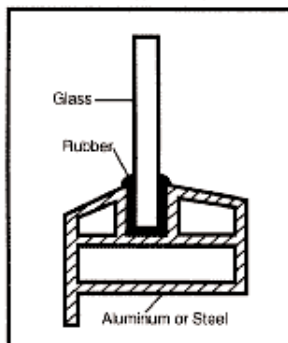

WOOD SASH

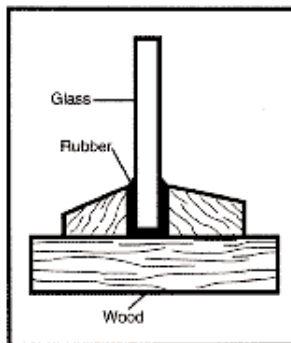

ALUMINUM OR STEEL SOLID

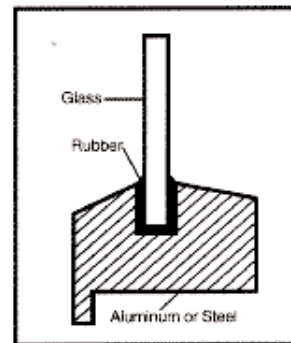

INDOOR STRUCTURAL POCKET

FAVORABLE

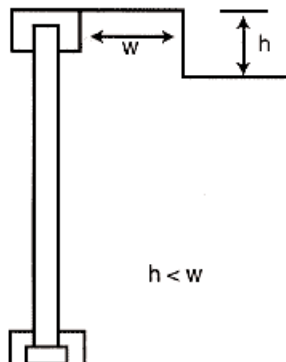

$$h < w$$

UNFAVORABLE

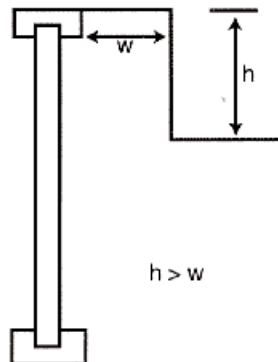

$$h > w$$

STRUCTURAL POCKET

STRUCTURAL POCKET

Window Type Section

1. If the window is **not square or rectangular** circle the shape that most closely resembles the actual shape of the window, or describe the shape.
2. If the window is square or rectangular check **NONE**.
3. Is the window area **greater than 20 square feet** (1,86 square meters)? Check the appropriate box.

Heating Register Location Section

1. Determine the location of the heating/cooling register and its position in relationship to the glass and any **indoor shading device**.
2. Check one of the four choices.

Other Considerations Section

1. The **Design Winter Temperature** is the lowest temperature expected at the building location. Select the proper temperature range from the three choices.
2. Select the appropriate **altitude** (above sea level) for the building.
3. An **adjacent reflecting surface** could be another building, a body of water, a hillside, etc. Indicate the color of this surface, if present.

Signatures Section

Obtain the requested signatures and date the form.



Glass Checklist Form - page 1

Request Number
Date 3M Received

Customer-Dealer Information

Customer Name _____ Dealer Name _____ Code _____
 Address _____ Address _____
 City _____ State _____ Zip _____ City _____ State _____ Zip _____
 Contact Name _____ Phone Number _____ Contact Name _____ Phone Number _____

Building Information

Glass Type (Check One)

- (1) Clear Single Pane
 (2) Tinted or Reflective Single Pane
 (3) Clear Double Pane
 (4) Tinted or Reflective Double Pane

Single Pane

- Annealed Laminated Tempered

Double Pane

- Exterior: Annealed Laminated Tempered
 Interior: Annealed Laminated Tempered

Glass Size in Inches (mm)

Width _____ by Height _____

Proposed Scotchtint Type(s) _____

Glass Thickness - Inch (mm)

Single _____

Glass Thickness - Double Pane - Inch (mm)

Exterior _____ Interior _____

Number of Windows _____

Building Age _____ Years

Previous Glass Failure Yes No

If Yes, Give Annual Percent _____

Indoor Shading

Type (Check One)

- (1) None (2) Drapes (3) Blinds

For Drapes

Color: (1) Light (2) Dark

Weave Type: (1) Open (2) Closed

For Blinds

Color: (1) Light (2) Dark

Ventilation of Indoor Shading

- (1) Ventilated (2) Non-Ventilated

Space Between Glass and Shading (Check One)

- (1) 2 to 6 inches (50-150 mm)
 (2) More than 6 inches (150 mm)

Outdoor Shading

Type (Circle one) or Check if none

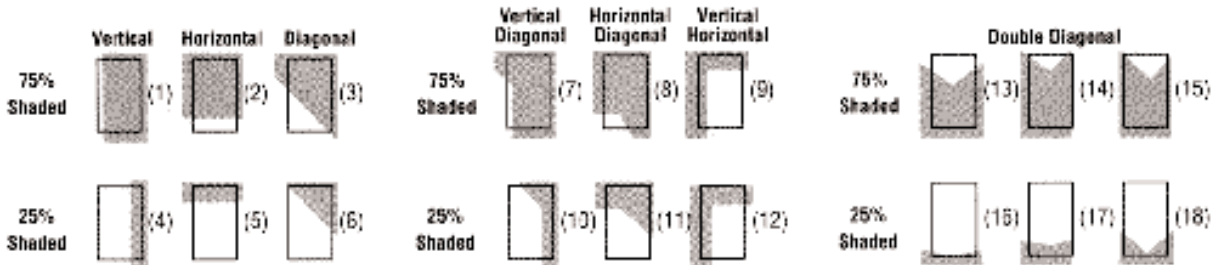

Walt - 225-45-05

Carry - 050002

Zak - 0500

04/05-7228-1

Glass Types and Thermal Stress



Glass Checklist Form - page 2

Window Framing

Framing System (Check One)

- (1) Structural Rubber Gasket
- (2) Wood Sash
- (3) Aluminum or Steel Tubular Thin
- (4) Aluminum or Steel Tubular Thick
- (5) Concrete
- (6) Aluminum or Steel Solid

Condition of Sealant

- (1) Resilient
- (2) Hardened

Condition of Frame

- (1) Good
- (2) Fair
- (3) Poor

Outdoor Glazing Stop Color

- (1) Black
- (2) Dark
- (3) Light

Sealant Type (Specify)

Indoor Structural Pocket Yes No

Window Type

Architectural Window Type (Circle one) or Check if none



(1)



(2)



(3)

(Other please draw) _____

(4)

Window larger than 20 square feet Yes No

NOTE: To determine square footage, multiply the height by width as though it were a rectangle.

Heating Register Location

Room Side of Indoor Shading or No Shading

- (1) Directed Away From Glass
- (2) Directed Towards Glass

Between Glass and Indoor Shading

- (3) Directed Away From Glass
- (4) Directed Towards Glass

Other Consideration

Design Winter Temperature (1) Below 0°F (-18°C) (2) Up to 40°F (4°C) (3) Above 40°F (4°C)

Altitude (1) Below 5000 Ft. (1525m) (2) At or Above 5000 Ft. (1525m)

Adjacent Reflecting Surface (1) None (2) Dark (3) Medium (4) White (snow)

Signatures

Customer _____ Date _____ Dealer _____ Date _____

I would like to receive this form back by:

Fax to phone number: _____

Mail to address: _____

EXPECTED EDGE STRESS REPORT

What Information Is Contained On The Expected Edge Stress Report?

THE REPORT IS DIVIDED INTO FOUR SECTIONS:

1. **General Information Section:**
 - a. Request Number and Date of Report
 - b. Customer and Dealer Information
 - c. General Glass Information Including:
 1. Glass type
 2. Typical glass size
 3. Glass edge area per window
 4. Total number of windows
 - d. Proposed Scotchtint film type
2. **Installation Conditions Section:**
 - a. General Building Conditions as outlined on Checklist Form
 - b. Specific Description of Building Condition
 - c. Thermal Stress Factors for these Specific Building Conditions
3. **Expected Edge Stress Section:**

Specific Expected Edge Stress Calculation for the indicated Scotchtint film
4. **Acceptable Maximum Stress Section:**
 - a. The Acceptable Maximum Stress for this situation
 - b. 3M™'s Recommendation: Accepted or Rejected

3M Window Film

Energy Savings

3M™ / AIMCAL DEMAND ANALYZER

Energy Savings Computer Program

Instructions for Demand Analyzer

Two Steps Required

Step 1 – Instructions → Demand Analyzer installation.

1. Close all applications on your PC.
2. Insert the Demand Analyzer CD into your CD ROM drive. This is an Auto Start CD, wait a few minutes for the installation to begin.

Note: If Auto Start is not functioning, please see instructions below for manual start.

Manual Start Instructions

- A. Insert the Demand Analyzer CD into your CD ROM drive.
- B. Go to **Start | Run** and type in **'d:\setup.exe'** and hit **'Enter'**

Note: 'd' is the letter of the CD-ROM drive.

3. Press **'Next'** to continue installation.

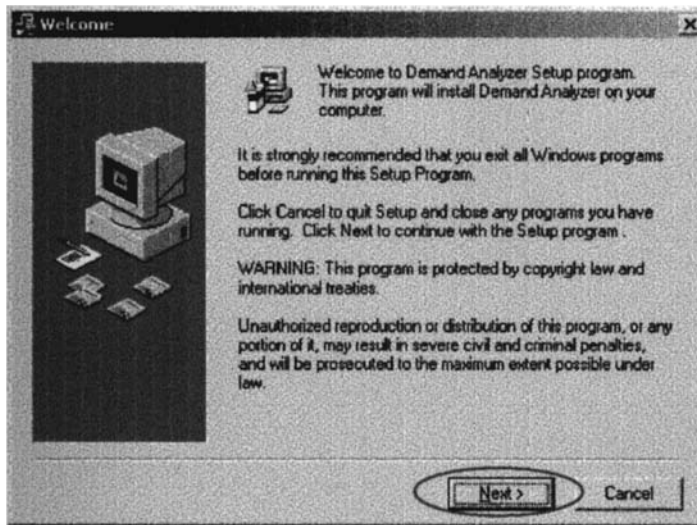

4. Accept defaults during the setup by pressing 'next' on each of the following screens.
 - End User License Agreement → **'Next'**
 - Get Registration Information → **'Next'**
 - Choose Destination Location → **'Next'**
 - Select Program Manager Group → **'Next'**
 - Start Installation → **'Next'**
5. Installation will begin and the following screen will display as the files are copied.

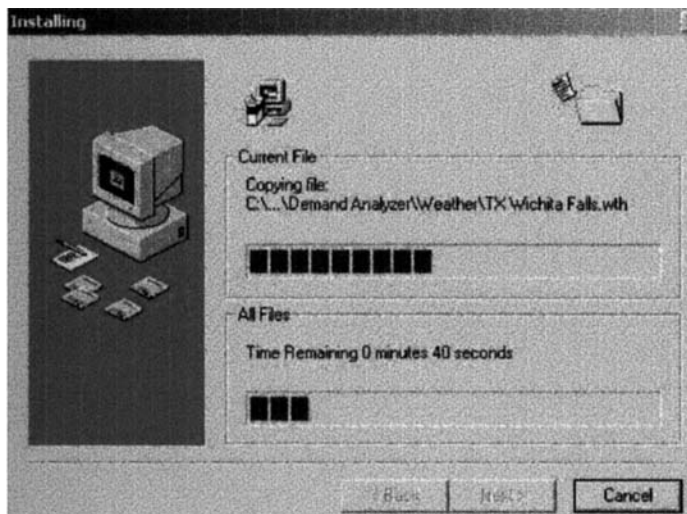

6. Press '**Finish**' to Complete Installation.



Step 2 – Instructions → 3M Components for Demand Analyzer installation.

1. Got to **Start | Run** and type in '**d:\3M Setup\setup.exe**' and hit '**Enter**'
Note: 'd' is the letter of the CD-ROM drive.
2. The 3M components of Demand Analyzer will be installed and the window will disappear when finished.

Note: If you do not complete Step 2 of the installation, you will be missing the 3M components/products when you try to create a report.

Start Demand Analyzer

1. '**Click**' on the Demand Analyzer icon on your desktop.



3M /AIMCAL Demand Analyzer

Easy Step-by-Step Instructions (Please read carefully)

Overview

Demand Analyzer is an easy-to-use, Windows-based program that allows the user to quickly create an energy analysis report detailing the energy savings from applying solar control films to almost any building. Even though Demand Analyzer uses the most sophisticated energy analysis methods available, you will find that it takes only a few minutes to prepare a very detailed and accurate energy analysis report.

When using Demand Analyzer the user creates computer “models” of the building in question. These models are created by completely describing the building and its utility costs within the program. This is done by choosing values for several building “parameters.” These parameters are everything about the building affecting its energy use and its annual energy costs (such as building location and climate, type of windows, cost of electricity, square footage, number of stories, type of cooling and heating systems, etc.).

To create an energy analysis report showing the effect of adding solar film to a building, it is necessary to create two building models. First, a “Base Case” model of the building as it currently exists (without solar film) is produced. Second, a model is created of the building with solar film applied. The user can create any number of models with film applied to compare the effect of different films. Once these models have been created the energy analysis report is prepared.

To make the process as easy as possible, Demand Analyzer has several complete model templates built into the program for the 17 most common building types (Large Office, Hospital, Motel, College, Large Retail, Small Retail, High School, Residence, etc.). This simplifies the modeling process as the user only modifies a few select parameters from these templates and does not need to enter all of the model information for each analysis.

Included in this document are step by step instructions for using Demand Analyzer. It has been written for those not completely comfortable with using a computer and includes very specific, detailed instructions. More information on how to use the program (in a less detailed manner) can be found using the **Help** menu option in Demand Analyzer. Also, included in the Demand Analyzer **Help** section is a Tutorial. Once you have followed the steps below to create a few building models, and create and print a few reports and graphs, you should be able to refer to the less detailed instructions in the Demand Analyzer Help and Tutorial sections.

In the text below, menu choices from Demand Analyzer’s or other program’s menu bars (along the top of a screen) are shown in **Bold**. Demand Analyzer building parameters and the names of windows or popup menus that will appear in Demand Analyzer are shown as ***italicized bold letters***. **IMPORTANT:** when describing the use of the computer mouse, the word “click” refers to clicking the left mouse button once. Do not double click or use the right mouse button unless specifically instructed to do so.

Again, the steps you will follow to create an energy analysis report using Demand Analyzer are:

1. Use Demand Analyzer Templates to create an Initial Base Case Model



2. Modify Initial Base Case Parameter Values to match existing building without film and create Final Base Case Model



3. Create Building Model With Film



4. & 5. Create Energy Analysis Report and Graphs (comparing Base Case to Model With Film)

Questions? Call Amy Randolph (651) 736-7530

11/9/01

1. Using Demand Analyzer Templates to create an Initial Base Case Model

After starting Demand Analyzer, from the menu bar choices at the top of the screen, click on **File**, then **New**, then **Building**.

The **New Building** window will appear on your screen. Options are shown for **Category**, **Building Type**, **Vintage**, **Description**, **Climate Zone**, and **Utility Rates**.

The **Category** name is optional and is used to group together common buildings (for example models for a particular client). You can choose the default “No Category” if desired or type in an appropriate name. If you have previously entered a **Category** name, and wish to add the new model to this category, you can click on the down arrow to the right of the **Category** box and choose a **Category** name from the list that appears. In the list that appears, the name that is highlighted can be changed by moving the mouse up or down, or by using the PgUp, PgDn, **↑**, or **↓** keys. Click the mouse when you have highlighted the desired **Category**.

Next, click on the down arrow to the right of the box beside **Building Type**, and choose from the list that appears the type of building you wish to analyze. Click on the type of building desired. This step is critically important, as many of the parameters defining the building depend upon the **Building Type** chosen. If you do not choose the correct **Building Type** you cannot expect the resulting energy analysis to be accurate.

By clicking on the down arrow to the right of the box beside **Vintage**, you can choose the date corresponding to when the building was built. There are three sets of dates to choose from. Again, the **Vintage** will alter many of the model parameters used, so be certain that the choice made is correct.

Next, click in the blank box next to **Description** and type a descriptive name for the building, such as “Building (without film).”

Clicking on the down arrow to the right of **Climate Zone**, choose the city nearest to the actual building location. Once you click on the down arrow, you can move quickly to the desired state or country by pressing the first letter of the state or country (or again you can move the mouse up or down, or use the PgUp, PgDn, **↑**, or **↓** keys).

Finally, unless you read more about **Utility Rates** in the Demand Analyzer Help screens, and know what you are doing, leave the Utility Rate box set to “default.”

It is important to make sure you have made the proper choices for the parameters shown in the **New Building** window, **BEFORE** proceeding further. Once you leave this window you cannot change some of the parameters shown. So, once you are sure you have the correct choices in the **New Building** window, click on OK. When you do so, you will notice that the building model is added to the **Buildings in Database** window (normally on the left side of the screen). Buildings in this window are grouped first by **Category** and second by **Building Type and Vintage**.

Now you are ready to modify the building parameters to more closely match the building you are analyzing.

2. Modify Initial Base Case Parameter Values to match existing building Without film and create Final Base Case Model

Once you have created an initial Base Case building model without film, you will need to modify some of the parameters within the model to match the specific building you are analyzing. When you first create the building model in Step 1 above, Demand Analyzer uses typical values for many of the parameters based on the **Building Type and Vintage** chosen.

The parameters that you may need to modify will depend on the **Building Type**. In Table 1 on the next page, is a summary of the different parameters you may need to modify by **Building Type**. If you do not have good information as to what value to enter for a given parameter, use the default value given by Demand Analyzer. Of course, the accuracy of the energy analysis will depend entirely upon the accuracy of the parameter values used.

To change the values of a parameter in a building model, you will first need to open the building parameter list for a building. Buildings are selected from the **Buildings in Database** window. If the building name needed is not shown in the **Buildings in Database** window, click the + symbol to the left of the **Category** for that building. Buildings are also grouped by **Building Type and Vintage** so you may need to click on the + symbol beside any of the **Building Type/Vintage** listings shown to show all of the buildings in that particular group in order to find your building. Once the building name needed is shown, double clicking a building name or clicking the + symbol beside the building name will display a list of building parameter groups. Double clicking on the name of a particular parameter group or clicking on the + symbol beside any of these parameter groups will show all of the individual parameters for that group.

To change a parameter value, click on the parameter name. If the parameter is a simple Yes/No type, then the box is either checked (meaning Yes) or unchecked (meaning No). Otherwise, the parameter may be edited in the popup box that appears when you click on the parameter. Notice that as any parameter is changed to a non-default value, the box next to it is changed to have a blue background. Parameters that have a gray box are deactivated because of the selection of another parameter. A summary for the building being edited is displayed in a separate building window showing every parameter that is not set to the default value (the window title is the name of the building).

Be certain that you choose the correct **Window Glass Type** values for each orientation (North, South, East and West) in the **Envelope** parameter group. Only four orientations are allowed for windows, but it is possible to change the default N-E-S-W to NE-SE-SW-NW by simply changing the building azimuth to 45. That effectively rotates the entire building. Be sure to choose a **Window Glass Type** without film.

You can also change a building's **Description, Climate Zone, or Utility Rates** after creating a model, by first single clicking on a building name in the **Buildings in Database** window to highlight a specific building. Next, single click the highlighted building name and the **New Building** popup window will appear. Keep in mind that you will not be able to change the **Category Building Type or Vintage**.

To read more about the parameters listed in the table on the next page and all available parameters, click on the Demand Analyzer **Help** menu option at the top of the screen, then click on **Contents, General, and Index of Parameters**. A screen will appear that shows every possible building parameter you can alter in Demand Analyzer. If you click on any of the parameters shown, a brief description will appear. To return to Demand Analyzer from the Help screen, click on the Close button (the **X** button) in the upper right corner of the Help screen.

Table 1 - List of Parameters by Building Type (parameters that should be modified from template).

Note: Only those Parameter Groups and Parameters that are the most important to provide an accurate analysis are shown below. Other parameters may also be edited as necessary.

Parameter Group	Individual Parameter	Large Scale Commercial							Small Scale Commercial							Residential		
		Large Office	Large Retail	Hospital	Nursing Home	High School	College	Hotel	Small Office	Small Retail	Sit Down Rest	Fast Food Rest	Grocery Store	Ware-House	Primary School	Motel	Single Family Res.	Multi Family Res.
General																		
	Floor Area	X	X	X	X	X	X	X	X	X	X	X	X	X	X	X	X	X
	Number of Stories	X						X										
	Operating Schedule					X					X	X	X		X			
Utility Rates																		
	Electricity:																	
	Electricity cost per kwh	X	X	X	X	X	X	X	X	X	X	X	X	X	X	X	X	X
	Natural Gas:																	
	Energy cost per Therm	X	X	X	X	X	X	X	X	X	X	X	X	X	X	X	X	X
Thermostat Setting																		
		X	X	X	X	X	X	X	X	X	X	X	X	X	X	X	X	X
Envelope																		
	Adjacent Shading	X	X	X	X	X	X	X	X	X	X	X	X	X	X	X	X	X
	Window Area	X	X	X	X	X	X	X	X	X	X	X	X	X	X	X	X	X
	Window Setback	X	X	X	X	X	X	X	X	X	X	X	X	X	X	X	X	X
	Window Shading	X	X	X	X	X	X	X	X	X	X	X	X	X	X	X	X	X
	Window Glass Type	X	X	X	X	X	X	X	X	X	X	X	X	X	X	X	X	X
Air Distribution																		
	Air Handler Type	X	X	X	X	X	X	X										
Central Plant																		
	Heating Plant	X	X	X	X	X	X	X										
	Cooling Plant	X	X	X	X	X	X	X										
	Cooling Tower	X	X	X	X	X	X	X										
HVAC System																		
	Heating System	X	X	X	X	X	X	X										
	Cooling System								X	X	X	X	X	X	X			
	Cooling Tower								X	X	X	X	X	X	X			
DHW & HVAC Systems																		
	HVAC System																	
	Heating System																X	X
	Cooling System																X	X

3. Creating Building Model with film

Once you have followed Steps 1 and 2 to create the Base Case building model without film, you are ready to create the building model with film. Demand Analyzer will allow you to copy the Base Case building model you have just created, saving you from editing most of the parameter values again. Of course, it will be necessary to change the **Window Glass Type** parameter for the model with film. This parameter will specify which film will be applied to the windows in the model with film.

To copy a building model, once you are sure you have modified all of the necessary building parameters for the Base Case model, collapse the building parameter list by clicking on the “-” symbol beside the building name you are working on. The name of the Base Case building without film should remain highlighted. If the correct building name is not highlighted, click on the correct name once. Then click on the **Edit** command on the menu list at the top of the screen. Then click **Copy**. Demand Analyzer will ask you if you are sure you want to copy the building chosen. Click Yes. A **Copy Building** popup window will appear showing a blank **Category** and the **Description** for the building copied. Click on the down arrow beside **Category** and choose the same **Category** as used for the Base Case building. Next, click on the **Description** box and edit the description to indicate that the new model includes film applied to the windows. For example: “Building (with film A)”. It is a good idea to include the exact film name in the **Description** for buildings with film as you may want to compare several film types. So you may have “Building (with Film A)”, “Building (with Film B)”, etc. Keep in mind that each model will contain only information about the building for a single film type. If you want to compare different films, you will need to create a new model for each film. Also, the **Description** name will appear on any graphs or printouts created so adding film names will make it easy to compare the effect of different film types.

Once you have entered a **Description** for the building with film click on OK. You can create additional models for additional film types by copying the building again. Be sure to choose the same **Category** so that the models are grouped together in the **Buildings in Database** window.

Since the model or models you have just created are identical to the Base Case model without film, the only parameter you will need to change is the **Window Glass Type** parameter to add film to the building. Again, click on the + symbol beside the Building Name, then click on the + beside **Envelope**, then click on the **Window Glass Type** for a given orientation. From the popup box that appears, choose the appropriate window & film combination. For example, if you chose “Single Clear (no film)” for the model without film, be sure that when you choose a film name, the window type also is “Single Clear”, such as “Single Clear with Film A” (Note: You can add film to any of the orientations or all of them. If you do not wish to add film to a given orientation such as North, do not edit the **Window Glass Type** for that orientation. You can also add different film types to different orientations).

Edit each building model with film, being sure to edit the **Window Glass Type** for **ALL** orientations desired.

Now that you have created a Base Case Model without film and a model with film, you are ready to create the energy analysis report.

4. Creating Energy Analysis Report

Once you have created a Base Case model for your building without film and then a model with film, it is a simple matter to create a detailed report showing the energy and cost savings from adding film.

From the menu choices at the top of the Demand Analyzer screen, click on **File**, then **New**, then **Report**.

When the **“Report and Building Selection”** popup window appears, choose “Economic Analysis” in the Report option box.

Next use the building tree that is shown to choose the buildings for your report. You may need to expand the tree to find your buildings by clicking on the + symbol beside the **Category** for your buildings. If there is more than one **Building Type** in this **Category** click on the + symbol beside the **Building Type** for the models just created. Next click the box beside each building you wish to include in the report and click on Next.

Fill in the information on the **“Report Parameters”** screen and press Next.

Make sure the building model name without film is identified as your “Base Case” by ensuring that the box beside the building model without film is checked.

Using the Tab key, move the cursor so that you can now enter the total installed cost for the film for each building with film. This is the total quote for the entire job, NOT the cost per square foot. So if you are creating a report for a 10,000 square foot job and you are charging \$3.00 per square foot, you would enter \$30,000. Be sure to include a cost for each model with film. Then press Finish.

At this point you may see a Demand Analyzer message that reads “One or more buildings with no simulation. Run required simulations?” Click on Yes. Depending on the number of models that will be simulated and the speed of your computer, this may take a few minutes. When the Simulation Progress meter is 100%, click on OK.

Demand Analyzer will create a report with a cover page, an Economic Analysis Summary Page, and a Buildings Parameter Summary. The cover page will show the annual savings and payback for the film with the greatest savings along with general information about Demand Analyzer. The Economic Analysis Summary Page will show the savings and payback for each film option chosen. The Buildings Parameter Summary lists all of the model parameters chosen for each model.

If you are using Microsoft Word, you can save the report by choosing **File, Save As**, choose a directory different from the default \Temp directory shown, and then click on Save. **IMPORTANT: DO NOT SAVE THE FILE TO THE \TEMP DIRECTORY EVEN THOUGH THIS IS THE DEFAULT DIRECTORY. ALL FILES FROM THE \TEMP DIRECTORY ARE ERASED WHEN DEMAND ANALYZER IS CLOSED. IT IS BEST TO USE A DIRECTORY COMPLETELY APART FROM ANY DEMAND ANALYZER DIRECTORY (SUCH AS USING C:\ENERGY REPORTS AS A DIRECTORY FOR ALL YOUR ANALYSIS REPORTS. ALSO, DO NOT CHANGE THE “SAVE AS TYPE” FROM “RICH TEXT FORMAT” TO “WORD DOCUMENT”. LEAVE AS “RICH TEXT FORMAT.”**

Again, if using MS Word, you can print the report by choosing **File**, then **Print**.

5. Creating Graphs

You can easily create graphs that illustrate the energy savings from adding different solar films. These graphs can then be printed out and attached to the “**Economic Analysis Report.**” To create a graph, from the menu choices at the top of the Demand Analyzer screen, click on **File**, then **New**, then **Graph**. Next click on the **Annual Cost** option. There are several graph types to choose from and you will need to experiment with each of these to see which graphs would be the most useful for your needs. The most common graph, however, will certainly be the **Annual Cost** graph. This graph shows the total annual cost for each building model chosen.

Just as you did to create a report in step 4 above, you will next choose the buildings to be included in the graph. When the **Select Buildings to Graph** window appears, click on the + symbol beside the **Category** for the buildings to be included on the graph. If there is more than one **Building Type** in this **Category** click on the + symbol beside the **Building Type** for the models you wish to graph. Next click the box beside each building you wish to include in the report and click OK. The buildings will be shown on the graph from left to right in the order chosen. At this point you may see a Demand Analyzer message that reads “One or more buildings with no simulation. Run required simulations?” Click on Yes. Depending on the number of models that will be simulated and the speed of your computer, this may take a few minutes. When the Simulation Progress meter is 100%, click on OK. You will then be prompted for the Graph Title to use. You can accept the default title shown by clicking OK, or enter your own title and click OK. The graph will appear in a small window on your screen. Click on the Maximize button (the symbol in the upper right section of the graph window that appears) to enlarge the graph.

From the graph window you can use the graph window menu options to change the appearance of the graph or simply print the graph by clicking on **File, Print** (be sure to use the **File, Print** command from the graph window menu option list, not the main Demand Analyzer menu options at the very top of the screen).

If you have problems with the graph and legends appearing on separate pages, from the graph window, click on **File, Print Preview**, and under the “Options” box make certain that no check is in the box beside “Separate Legend”. Notice that you can also change the margins or orientation of your graph from this screen, if needed to improve the appearance of the printed graph.

6. Other Topics

A. English (Inch-Pound) or Metric (SI) Units

You can use either system of units by clicking on Options from the Demand Analyzer main menu bar, then choosing the system of units choice. You can switch between the two systems at any time.

B. Currency other than Dollars, \$

To have reports and graphs print a currency symbol other than \$, edit the default.ecn file in the Program Files\Demand Analyzer\Rates directory using Word or Notepad, or from Windows Explorer in this directory, double-click the default.ecn file to edit the file. The first few lines of this file should look like:

```
$ currency = $  
INPUT ECONOMICS ..  
ECONOMICS-REPORT SUMMARY (ES-D) ..
```

The symbol after “\$ currency =” on the first line is the symbol that will be used in reports and graphs. For example, to use British Pounds, you would edit the first line to read:

```
$ currency = £
```

Be careful not to change any other portion of this file. Save the file after making this change.

C. Non-square buildings or buildings with more than four sides

The default building geometry for larger building types is a square building. If the building you are modeling is rectangular, you should change the Aspect Ratio parameter, which is a parameter within the General parameter group. Use the Demand Analyzer Help section to learn more about changing the Aspect Ratio.

Similarly, if the building you are modeling does not face true North, South, East and West, you should edit the Building Azimuth parameter to rotate your model as needed. Again, see the Demand Analyzer Help section for assistance.

If the building you are modeling has more than four sides, you will need to apportion the square footage of glass area in some manner to the four sides available in Demand Analyzer. For example, if you have glass facing North, South, East, West and Southwest, you could evenly divide the square footage of Southwestern facing windows between South and West.

D. Fuel Oil as a heating fuel source

Although rare, there are some buildings that may use Fuel Oil as a heating fuel. Due to the rarity of this situation, Demand Analyzer unfortunately does not permit choosing Fuel Oil as a heating fuel source. Therefore, if you are modeling a building where the heating fuel is fuel oil you will need to make the following modifications to your model.

If fuel oil is the heating fuel, you will need to enter a value for the Natural Gas **Energy Cost per Therm** under the **Utility Rates** parameter group. To do this, use Table 2 on the following page to convert the fuel oil cost per gallon to an equivalent Natural Gas **Energy Cost per Therm**. For example, if fuel oil costs 1.80 per gallon, you would enter 1.38 per therm as the Energy Cost per Therm for Natural Gas. The two costs shown take into account for the likely differences between the efficiencies of fuel oil versus natural gas systems, so you do not need to adjust the efficiency of the heating plant that Demand Analyzer uses. You should keep in mind that there is no way to change the appearance of the words “Natural Gas” or “therms” in graphs and reports, so be aware of this before presenting results to your customer.

Since solar control film has a much greater effect on the cooling energy costs than heating fuel costs, this method of adjusting your model is reasonable.

Table 2 - Equivalent Fuel Oil and Natural Gas Price Values.

If Fuel Oil Cost per Gallon is	Enter this value for Natural Gas Energy Cost per therm	If Fuel Oil Cost per Gallon is	Enter this value for Natural Gas Energy Cost per therm
0.20	0.15	6.20	4.77
0.40	0.31	6.40	4.92
0.60	0.46	6.60	5.08
0.80	0.62	6.80	5.23
1.00	0.77	7.00	5.38
1.20	0.92	7.20	5.54
1.40	1.08	7.40	5.69
1.60	1.23	7.60	5.85
1.80	1.38	7.80	6.00
2.00	1.54	8.00	6.15
2.20	1.69	8.20	6.31
2.40	1.85	8.40	6.46
2.60	2.00	8.60	6.62
2.80	2.15	8.80	6.77
3.00	2.31	9.00	6.92
3.20	2.46	9.20	7.08
3.40	2.62	9.40	7.23
3.60	2.77	9.60	7.38
3.80	2.92	9.80	7.54
4.00	3.08	10.00	7.69
4.20	3.23	10.20	7.85
4.40	3.38	10.40	8.00
4.60	3.54	10.60	8.15
4.80	3.69	10.80	8.31
5.00	3.85	11.00	8.46
5.20	4.00	11.20	8.62
5.40	4.15	11.40	8.77
5.60	4.31	11.60	8.92
5.80	4.46	11.80	9.08
6.00	4.62	12.00	9.23

Or, use the following formula:

(Fuel Oil Cost Per Gallon) divided by 1.30 = Energy Cost per therm for Natural Gas

3M Window Film

Warranties

US Warranty Information

- Program Details
- Coverage
- Warranty Application Form
- Instructions
- Glass Checklist
- Warranty Example

US WARRANTY INFORMATION

PROGRAM DETAILS

3M Window Film Warranty Program Details

COMMERCIAL WARRANTY

Thermal shock glass breakage — 60 months from the original installation start date.

RESIDENTIAL WARRANTY

Thermal shock glass breakage — 60 months from the original installation start date.

Seal failure - 40 months seal failure coverage provided customer has current coverage from window manufacture.

WARRANTY COVERAGE



Warranty Coverage Residential Application

Limited Lifetime Warranty

P18ARL	ULTRA600	NV-45
RE20NEARL	S35NEAR400	CS-5
RE35NEARL	S50NEAR400	CS-20
RE50NEARL	S20SIARL400	CS-35
RE70NEARL	SH7CLARL	CS-50
RE35SIAR	SH8CLARL	CS-20 BRONZE
RE50NIARL	SH14CLARL	CS-35 BRONZE
RE35AMARL	NV-15	CS-50 BRONZE
SCLARL150	NV-25	
SCLARL400	NV-35	

Limited 5 Year Warranty

RE15SIARXL
 LE20SIAR
 LE35AMARL
 SH2MA ML
 SH2PT SA
 SH2PT YA
 SH2EM OS
 SH2EM LA
 SH2MA MM

WARRANTY COVERAGE



Warranty Coverage Commercial Application

Limited 10 Year Warranty

P18ARL	SCLARL400	NV-35
RE20NEARL	ULTRA600	NV-45
RE35NEARL	S35NEARL400	CS-5
RE50NEARL	S50NEARL400	CS-20
RE70NEARL	S20SIARL400	CS-35
RE35SIAR	SH8CLARL	CS-50
RE35AMARL	SH14CLARL	CS-20 BRONZE
RE50NIARL	NV-15	CS-35 BRONZE
SCLARL150	NV-25	CS-50 BRONZE

Limited 5 Year Warranty

RE15SIARXL
LE20SIAR
LE35AMARL
SH2MA ML
SH2PT SA
SH2PT YA
SH2EM OS
SH2EM LA
SH2MA MM

Warranty Application Form

INSTRUCTIONS

3M Glass Checklist Instructions

- A glass checklist must be completed for restricted film and glass combinations and for restricted situations.
- If a glass checklist is required, an approved glass checklist must be attached to the warranty application. If a glass checklist is required, but is not attached to the warranty application, glass breakage/seal failure will not be covered by 3M. It will be the responsibility of the dealer to cover any claims.
- The glass checklist may be faxed in or sent in for processing. The fax number and address are on the glass checklist form.
- Glass checklists will be processed within 24 hours of our receiving the form (Monday through Friday). Indicate on the form whether you would like the information faxed or mailed back to you. If it is not indicated on the form, it will be mailed back to you.

3M Scotchtint™ and Scotchshield™ Window Film Restricted Information

A glass Checklist Form must be submitted for the following applications:

Restricted Film and Glass Combinations

Film Type	Single Pane	Double Pane Glass	
	Clear or Tinted	Clear/Clear	Tinted/Clear
CS-5	Restricted	Restricted *	Restricted *
CS-20	Restricted	Restricted *	Restricted *
CS-20 Bronze	Restricted	Restricted *	Restricted *
SPCS-10	Restricted	Restricted *	Restricted *
SPCS-20	Restricted	Restricted *	Restricted *
SPCS-35	Restricted	Restricted	Restricted
RE20NEARL		Restricted	Restricted

*** Application Not Recommended**

Restricted Situations (All Window Films)

1. Single Pane glass larger than 100 square feet (9.3 square meters).
2. Double pane glass larger than 40 square feet (3.7 square meters).
3. Clear glass thicker than 3/8 inch (9.5mm).
4. Tinted glass thicker than 1/4 inch (6mm).
5. Architectural shading from exterior overhangs, extensions, columns, pillars, etc.
6. Window framing systems of concrete, solid aluminum or solid steel.
7. Glass where sealant or glazing compound has hardened.
8. Buildings with more than 1% previous glass breakage or problems over the last two (2) years.
9. Reflective Glass.
10. Laminated glass in single pane or double pane.
11. Window where frame is damaged.
12. Architecturally odd-shaped windows (half moons, cathedral, etc.) larger than 20 square feet.

(NOTE: to determine square footage, multiply the height by the width as though it were a rectangle.)

**A Glass Checklist Form SHOULD NOT be submitted for the following applications:
Application Not Recommended. No Glass Breakage/Seal Failure Warranty Applies
To The Following Applications.**

1. Wired, textured or patterned glass.
2. Triple pane glass or double pane glass in conjunction with a suspended film.
3. Partial applications of film glass.
4. Applications of more than one tinted or reflective film to glass.
5. Visible brittle, chipped, cracked or otherwise damaged glass.
6. Glass blocks.

**Expected Edge Stress
For Glass With Existing Building Conditions**

Date: 10/15/97

Request Number : 4036077

Customer Name and Building Location 3M Consumer Safety and Light Management

Glass Type : Clear Double Pane

Typical Glass Size(W,H,T) : 54.00in 70.00in .25in

Glass Edge Area per Window : 62.0 Sq. in.

Total Number of Windows : 2

Proposed Scotchtint Film Type : RE50NEARL

Installation Conditions

Condition	Description	Thermal Stress Factors	
		Interior	Exterior
Previous Breakage	No	0.00	0.00
Age of Building (Years)	2	0.50	0.50
Glass Type	Double	0.60	1.00
Indoor Shading	None	0.00	0.00
Indoor Structural Pocket	No	0.00	0.00
Outdoor Shading (Dia. No.)	6	2.80	2.80
Frame Type	Wood	-0.30	0.00
Condition of Frame	Good	0.00	0.00
Condition of Sealant	Resilient	0.00	0.00
Outdoor Glazing Stop Color	Black	-0.20	-0.40
Heating Register Location	Roomside Away	0.00	0.00
Design Winter Temperature	Below 0	1.00	0.50
Altitude	Below 5000ft.	0.00	0.10
Adjacent Reflecting Surface	None	0.00	0.00
Architectural Windows	None	0.00	0.00
Window > 20 Sq. ft.	No	0.00	0.00
		5.40	5.30

Expected Edge Stress

Exterior Glass

5.30 (Total) x 210(Scotchtint Stress Factor = approx. 1113 (psi)

Interior Glass

5.40 (Total) x 510(Scotchtint Stress Factor) = approx. 2754 (psi)

Acceptable Maximum Stress

Exterior Annealed 3225(psi)

Interior Annealed 3225(psi)

Recommendation: >>Accepted<<



Glass Checklist Form - page 1

Request Number
Date 3M Received

Customer-Dealer Information

Customer Name _____ Dealer Name _____ Code _____
 Address _____ Address _____
 City _____ State _____ Zip _____ City _____ State _____ Zip _____
 Contact Name _____ Phone Number _____ Contact Name _____ Phone Number _____

Building Information

Glass Type (Check One)

- (1) Clear Single Pane
- (2) Tinted or Reflective Single Pane
- (3) Clear Double Pane
- (4) Tinted or Reflective Double Pane

Single Pane

- Annealed Laminated Tempered

Double Pane

- Exterior: Annealed Laminated Tempered
 Interior: Annealed Laminated Tempered

Glass Size in Inches (mm)

Width _____ by Height _____

Proposed Scotchlint Type(s)

Glass Thickness - Inch (mm)

Single _____

Glass Thickness - Double Pane - Inch (mm)

Exterior _____ Interior _____

Number of Windows _____

Building Age _____ Years

Previous Glass Failure Yes No

If Yes, Give Annual Percent _____

Indoor Shading

Type (Check One)

- (1) None (2) Drapes (3) Blinds

For Drapes

Color: (1) Light (2) Dark

Weave Type: (1) Open (2) Closed

For Blinds

Color: (1) Light (2) Dark

Ventilation of Indoor Shading

- (1) Ventilated (2) Non-Ventilated

Space Between Glass and Shading (Check One)

(1) 2 to 6 inches (50-150 mm)

(2) More than 6 inches (150 mm)

Outdoor Shading

Type (Circle one) or Check if none

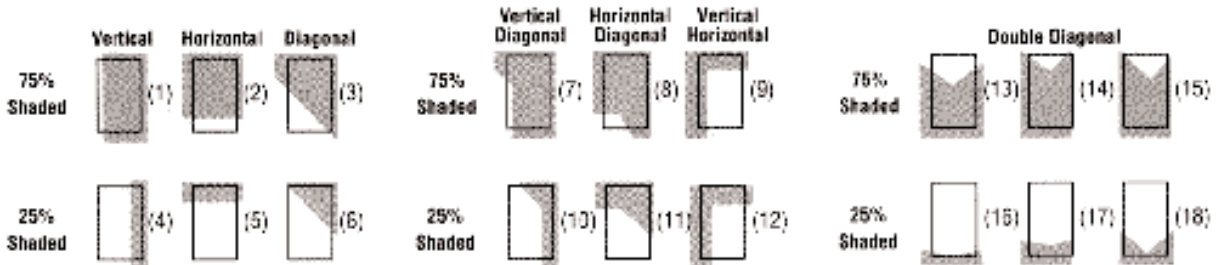

White - 225-48-08

Gray - 045-00-01

Pink - 045-00-01

04/016-7226-1



Glass Checklist Form - page 2

Window Framing

Framing System (Check One)

- (1) Structural Rubber Gasket
- (2) Wood Sash
- (3) Aluminum or Steel Tubular Thin
- (4) Aluminum or Steel Tubular Thick
- (5) Concrete
- (6) Aluminum or Steel Solid

Condition of Sealant

- (1) Resilient
- (2) Hardened

Condition of Frame

- (1) Good
- (2) Fair
- (3) Poor

Outdoor Glazing Stop Color

- (1) Black
- (2) Dark
- (3) Light

Sealant Type (Specify)

Indoor Structural Pocket Yes No

Window Type

Architectural Window Type (Circle one) or Check if none



(1)



(2)



(3)

(Other please draw) _____ (4)

Window larger than 20 square feet Yes No

NOTE: To determine square footage, multiply the height by width as though it were a rectangle.

Heating Register Location

Room Side of Indoor Shading or No Shading

- (1) Directed Away From Glass
- (2) Directed Towards Glass

Between Glass and Indoor Shading

- (3) Directed Away From Glass
- (4) Directed Towards Glass

Other Consideration

Design Winter Temperature (1) Below 0°F (-18°C) (2) Up to 40°F (4°C) (3) Above 40°F (4°C)

Altitude (1) Below 5000 Ft. (1525m) (2) At or Above 5000 Ft. (1525m)

Adjacent Reflecting Surface (1) None (2) Dark (3) Medium (4) White (snow)

Signatures

Customer _____ Date _____ Dealer _____ Date _____

Fax this form to: 414/238-4949

or mail to: 3M Specified Construction Products Department
Warranty Program
6000 West Executive Drive
P.O. Box 249
Mequon, WI 53092-0249

I would like to receive this form back by:

- Fax to phone number: _____
- Mail to address: _____

3M Warranty Examples

SCOTCHTINT™ & SCOTCHSHIELD™ WINDOW FILM

Commercial Limited 5 Year Quality Promise

SCOTCHTINT™ & SCOTCHSHIELD™ WINDOW FILM

Residential Limited 5 Year Quality Promise

SCOTCHTINT™ WINDOW FILM

Commercial Limited 10 Year Quality Promise

SCOTCHSHIELD™ ULTRA SAFETY & SECURITY WINDOW FILM

Commercial Limited 10 Year Quality Promise

SCOTCHTINT™ WINDOW FILM

Residential Limited Lifetime Quality Promise

SCOTCHSHIELD™ ULTRA SAFETY & SECURITY WINDOW FILM

Residential Limited Lifetime Quality Promise

3M Warranty

Window Film

Commercial Limited 5 Year Quality Promise

3M and the Authorized Consumer Safety and Light Management Dealer (collectively referred to as “Seller”) warrant that for a period of five (5) years from the start of installation, **Scotchint and Scotchshield Window Films** will:

- Maintain **Solar Reflective Properties** without cracking, crazing or peeling.
- Maintain **Adhesion Properties** without blistering, bubbling or delaminating from the glass.

Exception to the above warranty: Outdoor type window (RE155IX) is warranted for two (2) years.

In the event the product is found to be defective under this warranty, Seller will:

- Replace the **Quantity of Film** proved to be defective.
- Provide **Removal and Reapplication Labor Free of Charge**.

If the window film was installed using the Ultraflex System, the following additional warranties apply:

Silicone structural adhesive will maintain its integrity, and will not change color for a period of ten (10) years from date of installation. This shall not cover failure due to disintegration of the underlying substrate, movement of the structure exceeding specification for elongation and/or compression, or changes in appearance of the adhesive appearance due to dirt or other contaminate.

This warranty is provided only to the original purchaser and is not transferable.

Seller also warrants against **glass failure** due to thermal shock fracture (maximum value of \$500 per window) caused only as a direct result of the application of Scotchint and Scotchshield films provided the film is applied to recommended types of glass and the glass failure is reported to the Seller within the specified time (listed below) from the start of the installation.

*Sixty (60) months coverage against thermal shock fracture

There is a consumer deductible of \$25.00 (or 5% of the replacement cost, whichever is greater) per claim.

Any glass failure covered by this warranty must be reviewed by Seller prior to repair, and only covers film and glass replacement.

To obtain warranty service for either defective film or glass failure, please contact your Authorized Scotchint and Scotchshield Dealer.

This warranty is void if the product has been subjected to abuse or improper care. Seller should not be liable in either tort or contract for any loss or damage, direct, indirect, special, consequential, or incidental, arising out of the use or inability to use this product. Some states or provinces do not allow the exclusion or limitation of incidental or consequential damages, so the above limitations may not apply to you. **THIS WARRANTY GIVES YOU SPECIFIC LEGAL RIGHTS AND YOU MAY ALSO HAVE OTHER RIGHTS WHICH VARY FROM STATE TO STATE OR PROVINCE TO PROVINCE**

This warranty covers continental U.S. and Canadian installations only.

Important Notice: Window Care

Scotchint and Scotchshield Window Films may be washed with common washing solutions, including ammonia based products, thirty (30) days after installation. Abrasive type cleaning agents and bristle brushes which would scratch the film must not be used. Synthetic sponges, squeegees, or soft cloths are recommended to be used with the cleaning solution. To maintain your warranty, do not use tape or other adhesive products on the film.

After installation, there may be hazy appearance on your windows. This condition is temporary and is caused by the moisture that is present when applying film. This hazy appearance will disappear after the film dries, however, it may take up to 30 days for the film to completely dry.

3M Warranty

Window Film

Residential Limited 5 Year Quality Promise

3M and the Authorized Consumer Safety and Light Management Dealer (collectively referred to as “Seller”) warrant that for a period of five (5) years from the start of installation, **Scotchint and Scotchshield Window Films** will:

- Maintain **Solar Reflective Properties** without cracking, crazing or peeling.
- Maintain **Adhesion Properties** without blistering, bubbling or delaminating from the glass.
- Maintain **Strength, Tear and Penetration Resistant Properties**.

Exception to the above warranty: Outdoor type window (RE155IX) is warranted for two (2) years.

In the event the product is found to be defective under this warranty, Seller will:

- Replace the **Quantity of Film** proved to be defective.
- Provide **Removal and Reapplication Labor Free of Charge**.

If the window film was installed using the Ultraflex System, the following additional warranties apply:

Silicone structural adhesive will maintain its integrity, and will not change color for a period of ten (10) years from date of installation. This shall not cover failure due to disintegration of the underlying substrate, movement of the structure exceeding specification for elongation and/or compression, or changes in appearance of the adhesive appearance due to dirt or other contaminate.

This warranty is provided only to the original purchaser and is not transferable.

Seller also warrants against **glass failure** due to thermal shock fracture or seal failure, (maximum value of \$500 per window) caused only as a direct result of the application of Scotchint and Scotchshield films provided the film is applied to recommended types of glass and the glass failure is reported to the Seller within the specified time (listed below) from the start of the installation.

*Sixty (60) months coverage against thermal shock fracture

*Forty (40) months coverage against seal failure if covered by original window manufacturer

There is a consumer deductible of \$25.00 (or 5% of the replacement cost, whichever is greater) per claim. Any glass failure covered by this warranty must be reviewed by Seller prior to repair, and only covers film and glass replacement.

To obtain warranty service for either defective film, glass failure, or seal failure, please contact your Authorized Scotchint and Scotchshield Dealer, Metro Solar Inc, at 516-681-9700.

This warranty is void if the product has been subjected to abuse or improper care. Seller should not be liable in either tort or contract for any loss or damage, direct, indirect, special, consequential, or incidental, arising out of the use or inability to use this product. Some states or provinces do not allow the exclusion or limitation of incidental or consequential damages, so the above limitations may not apply to you. **THIS WARRANTY GIVES YOU SPECIFIC LEGAL RIGHTS AND YOU MAY ALSO HAVE OTHER RIGHTS WHICH VARY FROM STATE TO STATE OR PROVINCE TO PROVINCE**

This warranty covers continental U.S. and Canadian installations only.

Important Notice: Window Care

Scotchint and Scotchshield Window Films may be washed with common washing solutions, including ammonia based products, thirty (30) days after installation. Abrasive type cleaning agents and bristle brushes which would scratch the film must not be used. Synthetic sponges, squeegees, or soft cloths are recommended to be used with the cleaning solution. To maintain your warranty, do not use tape or other adhesive products on the film.

After installation, there may be hazy appearance on your windows. This condition is temporary and is caused by the moisture that is present when applying film. This hazy appearance will disappear after the film dries, however, it may take up to 30 days for the film to completely dry.

3M Warranty

Window Film

Commercial Limited 10 Year Quality Promise

3M and the Authorized Consumer Safety and Light Management Dealer (collectively referred to as “Seller”) warrant that for a period of ten (10) years from the start of installation, **Scotchint Window Films** will:

- Maintain **Solar Reflective Properties** without cracking, crazing or peeling.
- Maintain **Adhesion Properties** without blistering, bubbling or delaminating from the glass.
- Maintain **Appearance** without discoloration.

In the event the product is found to be defective under this warranty, Seller will:

- Replace the **Quantity of Film** proved to be defective.
- Provide **Removal and Reapplication Labor Free of Charge**.

This warranty is provided only to the original purchaser and is not transferable.

Seller also warrants against **glass failure** due to thermal shock fracture (maximum value of \$500 per window) caused only as a direct result of the application of Scotchint films provided the film is applied to recommended types of glass and the glass failure is reported to the Seller within the specified time (listed below) from the start of the installation.

*Sixty (60) months coverage against thermal shock fracture

There is a consumer deductible of \$25.00 (or 5% of the replacement cost, whichever is greater) per claim. Any glass failure covered by this warranty must be reviewed by Seller prior to repair, and only covers film and glass replacement.

To obtain warranty service for either defective film or glass failure, please contact your Authorized Scotchint Dealer.

This warranty is void if the product has been subjected to abuse or improper care. Seller should not be liable in either tort or contract for any loss or damage, direct, indirect, special, consequential, or incidental, arising out of the use or inability to use this product. Some states or provinces do not allow the exclusion or limitation of incidental or consequential damages, so the above limitations may not apply to you. **THIS WARRANTY GIVES YOU SPECIFIC LEGAL RIGHTS AND YOU MAY ALSO HAVE OTHER RIGHTS WHICH VARY FROM STATE TO STATE OR PROVINCE TO PROVINCE**

This warranty covers continental U.S. and Canadian installations only.

Important Notice: Window Care

Scotchint Window Films may be washed with common washing solutions, including ammonia based products, thirty (30) days after installation. Abrasive type cleaning agents and bristle brushes which would scratch the film must not be used. Synthetic sponges, squeegees, or soft cloths are recommended to be used with the cleaning solution. To maintain your warranty, do not use tape or other adhesive products on the film.

After installation, there may be hazy appearance on your windows. This condition is temporary and is caused by the moisture that is present when applying film. This hazy appearance will disappear after the film dries, however, it may take up to 30 days for the film to completely dry.

3M Warranty

Ultra Safety & Security Window Film

Commercial Limited 10 Year Quality Promise

3M and the Authorized Consumer Safety and Light Management Dealer (collectively referred to as “Seller”) warrant that for a period of ten (10) years from the start of installation, **Scotchshield Ultra Films** will:

- Maintain **Solar Reflective Properties** without cracking, crazing or peeling.
- Maintain **Adhesion Properties** without blistering, bubbling or delaminating from the glass.
- Maintain **Appearance** without discoloration.
- Maintain **Strength, Tear and Penetration Resistant Properties**.

In the event the product is found to be defective under this warranty, Seller will:

- Replace the **Quantity of Film** proved to be defective.
- Provide **Removal and Reapplication Labor Free of Charge**.

If the window film was installed using the Ultraflex System, the following additional warranties apply:

Silicone structural adhesive will maintain its integrity, and will not change color for a period of ten (10) years from date of installation. This shall not cover failure due to disintegration of the underlying substrate, movement of the structure exceeding specification for elongation and/or compression, or changes in appearance of the adhesive appearance due to dirt or other contaminate.

This warranty is provided only to the original purchaser and is not transferable.

Seller also warrants against **glass failure** due to thermal shock fracture (maximum value of \$500 per window) caused only as a direct result of the application of Scotchshield films provided the film is applied to recommended types of glass and the glass failure is reported to the Seller within the specified time (listed below) from the start of the installation.

*Sixty (60) months coverage against thermal shock fracture

There is a consumer deductible of \$25.00 (or 5% of the replacement cost, whichever is greater) per claim. Any glass failure covered by this warranty must be reviewed by Seller prior to repair, and only covers film and glass replacement.

To obtain warranty service for either defective film or glass failure, please contact your Authorized Scotchtint and Scotchshield Dealer.

This warranty is void if the product has been subjected to abuse or improper care. Seller should not be liable in either tort or contract for any loss or damage, direct, indirect, special, consequential, or incidental, arising out of the use or inability to use this product. Some states or provinces do not allow the exclusion or limitation of incidental or consequential damages, so the above limitations may not apply to you. **THIS WARRANTY GIVES YOU SPECIFIC LEGAL RIGHTS AND YOU MAY ALSO HAVE OTHER RIGHTS WHICH VARY FROM STATE TO STATE OR PROVINCE TO PROVINCE**

This warranty covers continental U.S. and Canadian installations only.

Important Notice: Window Care

Scotchshield Window Films may be washed with common washing solutions, including ammonia based products, thirty (30) days after installation. Abrasive type cleaning agents and bristle brushes which would scratch the film must not be used. Synthetic sponges, squeegees, or soft cloths are recommended to be used with the cleaning solution. To maintain your warranty, do not use tape or other adhesive products on the film.

After installation, there may be hazy appearance on your windows. This condition is temporary and is caused by the moisture that is present when applying film. This hazy appearance will disappear after the film dries, however, it may take up to 30 days for the film to completely dry.

3M Warranty

Window Film

Residential Limited Lifetime Quality Promise

3M and the Authorized Consumer Safety and Light Management Dealer (collectively referred to as “Seller”) warrant that for as long as the original consumer of the **Scotchint Window Films** owns and lives in the home, **Scotchint Window Films** will:

- Maintain **Solar Reflective Properties** without cracking, crazing or peeling.
- Maintain **Adhesion Properties** without blistering, bubbling or delaminating from the glass.
- Maintain **Appearance** without discoloration.

In the event the product is found to be defective under this warranty, Seller will:

- Replace the **Quantity of Film** proved to be defective.
- Provide **Removal and Reapplication Labor Free of Charge**.

This warranty is provided only to the original purchaser and is not transferable.

Seller also warrants against **glass failure** due to thermal shock fracture or seal failure, (maximum value of \$500 per window) caused only as a direct result of the application of Scotchint films provided the film is applied to recommended types of glass and the glass failure is reported to the Seller within the specified time (listed below) from the start of the installation.

*Sixty (60) months coverage against thermal shock fracture

*Forty (40) months coverage against seal failure if covered by original window manufacturer

There is a consumer deductible of \$25.00 (or 5% of the replacement cost, whichever is greater) per claim. Any glass failure covered by this warranty must be reviewed by Seller prior to repair, and only covers film and glass replacement.

To obtain warranty service for either defective film, glass failure, or seal failure, please contact your Authorized Scotchint Dealer.

This warranty is void if the product has been subjected to abuse or improper care. Seller should not be liable in either tort or contract for any loss or damage, direct, indirect, special, consequential, or incidental, arising out of the use or inability to use this product. Some states or provinces do not allow the exclusion or limitation of incidental or consequential damages, so the above limitations may not apply to you. **THIS WARRANTY GIVES YOU SPECIFIC LEGAL RIGHTS AND YOU MAY ALSO HAVE OTHER RIGHTS WHICH VARY FROM STATE TO STATE OR PROVINCE TO PROVINCE**

This warranty covers continental U.S. and Canadian installations only.

Important Notice: Window Care

Scotchint Window Films may be washed with common washing solutions, including ammonia based products, thirty (30) days after installation. Abrasive type cleaning agents and bristle brushes which would scratch the film must not be used. Synthetic sponges, squeegees, or soft cloths are recommended to be used with the cleaning solution. To maintain your warranty, do not use tape or other adhesive products on the film.

After installation, there may be hazy appearance on your windows. This condition is temporary and is caused by the moisture that is present when applying film. This hazy appearance will disappear after the film dries, however, it may take up to 30 days for the film to completely dry.

3M Warranty

Ultra Safety & Security Window Film

Residential Limited Lifetime Quality Promise

3M and the Authorized Consumer Safety and Light Management Department Dealer (collectively referred to as "Seller") warrant that for as long as the original consumer of the **ScotchTint Window Films** owns and lives in the home, **ScotchTint Window Films** will:

- Maintain **Solar Reflective Properties** without cracking, crazing or peeling.
- Maintain **Adhesion Properties** without blistering, bubbling or delaminating from the glass.
- Maintain **Appearance** without discoloration.
- Maintain **Strength, Tear and Penetration Resistant Properties**.

In the event the product is found to be defective under this warranty, Seller will:

- Replace the **Quantity of Film** proved to be defective.
- Provide **Removal and Reapplication Labor Free of Charge**.

If the window film was installed using the Ultraflex System, the following additional warranties apply:

Silicone structural adhesive will maintain its integrity, and will not change color for a period of ten (10) years from date of installation. This shall not cover failure due to disintegration of the underlying substrate, movement of the structure exceeding specification for elongation and/or compression, or changes in appearance of the adhesive appearance due to dirt or other contaminate.

This warranty is provided only to the original purchaser and is not transferable.

Seller also warrants against **glass failure** due to thermal shock fracture (maximum value of \$500 per window) caused only as a direct result of the application of Scotchshield films provided the film is applied to recommended types of glass and the glass failure is reported to the Seller within the specified time (listed below) from the start of the installation.

*Sixty (60) months coverage against thermal shock fracture

*Forty (40) months coverage against seal failure if covered by original window manufacturer

There is a consumer deductible of \$25.00 (or 5% of the replacement cost, whichever is greater) per claim.

Any glass failure covered by this warranty must be reviewed by Seller prior to repair, and only covers film and glass replacement.

To obtain warranty service for either defective film, glass failure, or seal failure, please contact your Authorized Scotchshield Dealer, Metro Solar Inc, at 516-681-9700.

This warranty is void if the product has been subjected to abuse or improper care. Seller should not be liable in either tort or contract for any loss or damage, direct, indirect, special, consequential, or incidental, arising out of the use or inability to use this product. Some states or provinces do not allow the exclusion or limitation of incidental or consequential damages, so the above limitations may not apply to you. **THIS WARRANTY GIVES YOU SPECIFIC LEGAL RIGHTS AND YOU MAY ALSO HAVE OTHER RIGHTS WHICH VARY FROM STATE TO STATE OR PROVINCE TO PROVINCE**

This warranty covers continental U.S. and Canadian installations only.

Important Notice: Window Care

Scotchshield Window Films may be washed with common washing solutions, including ammonia based products, thirty (30) days after installation. Abrasive type cleaning agents and bristle brushes which would scratch the film must not be used. Synthetic sponges, squeegees, or soft cloths are recommended to be used with the cleaning solution. To maintain your warranty, do not use tape or other adhesive products on the film.

After installation, there may be hazy appearance on your windows. This condition is temporary and is caused by the moisture that is present when applying film. This hazy appearance will disappear after the film dries, however, it may take up to 30 days for the film to completely dry.

3M Window Film

Installation

Flat Glass

Tools & Equipment
Process

Automotive

Tools & Equipment
Process

Installation

FLAT GLASS

Tools And Equipment

Available from Authorized 3M™ Scotchtint™ Film Distributor

Film dispenser with spare cutter head assembly
Replacement blades for film dispenser
Three-gallon (11 liter) plastic PRESSURE spray tank - 8' - 10' (2-3m) plastic hose
Replacement nozzle for three-gallon spray tank
8" (20 cm) Window cleaning squeegee with replacement rubbers
20" (50 cm) Window cleaning squeegee with replacement rubbers
6" (15 cm) Film application squeegee with replacement blades
8" (20 cm) Film application squeegee with replacement blades
1" (25 cm) Window scraper with replacement blades
4" (10 cm) Window scraper with replacement blades
Five-way tool
Olfa knives with replacement break-away blades
Positioning solution (see page)
36" (90 cm) Straight ruler (metal)
72" (1,8 m) Straight ruler (metal)
Miscellaneous metal or plastic trim guides

Miscellaneous Hardware & Equipment Available locally

15' (5 m) or 25' (8 m) Flexible steel measuring ruler
Waist apron
Drop cloths (absorbent)
Lint-free towels
Scissors
Screwdrivers
Pliers
Claw hammer
Allen wrench set
Vacuum cleaner (aqua-vac)
Small paint brushes (for edge sealer)
3M™ Brand masking tape
Sponges
Edge Sealer - 3M™ Clear Auto Sealer - Part #08551 - for exterior and interior
Step ladders and extension ladders
Scaffolding or access equipment as required

Tool and Equipment Inspection

Inspect Before Leaving For Application Site

1. Film Dispenser
 - a. New sharp blades
 - b. Alignment of horizontal cutter
 - c. Spare blades
 - d. Clamp bar - surface clean and positive grip

2. Plastic Pressure Spray Tank
 - a. No Leaks
 - b. Flush out before filling

3. Squeegees
 - a. Clean
 - b. Blade edge - replace if worn or nicked

4. Application Squeegee Repair
 - a. Rub across edge with 400 or 600 grit 3M Wetordry™ brand sandpaper
 - b. Maintain good square edge
 - c. If nicks and chips are still present, use 200 or 300 grit 3M **Wetordry**™ brand sandpaper. Go back and finish off with 400 or 600 grit 3M **Wetordry**™ brand sandpaper.

5. Knives
 - a. Use break-away blades
 - b. Use new tip after 3 cuts
 - c. Use stainless steel blades

Film Inspection

Inspect Before Leaving For Application Site

1. Correct Film
2. Correct Sizes
3. Free of Visual Defects
 - a. Edge damage
 - b. Buckles
 - c. Wrinkles
4. Sufficient amount of film and proper run number

Window Preparation

1. If possible, Customer should provide clear access to window
2. Protect floor, carpet, window ledge, wall, etc., with suitable absorbent material
(drop cloth) - not plastic
3. Turn off or cover heating/AC and ventilation ducts
4. Set film dispenser when required
5. Have tools and supplies as close to the window as possible

Clean Glass and Frame

1. Wipe down window frame with damp cloth or sponge
2. If window putty or seal is old and cracked, tape or seal prior to washing glass
3. Wash window using pressure spray tank
4. If glazing is in good condition, flush edges
5. Scrape glass
6. Thoroughly rinse glass from top to bottom with pressure spray tank
7. Squeegee entire glass surface
8. Dry glass edge and window frame

Film Application

- I. Lightly Spray with Slip Solution.
- II. Cut Film 1" (2.5 cm) Wider and 1" (2.5 cm) Longer Than Glass Size.
- III. Lay Film on Glass with Adhesive Side Toward You.
- IV. Wash Off Overcoat.

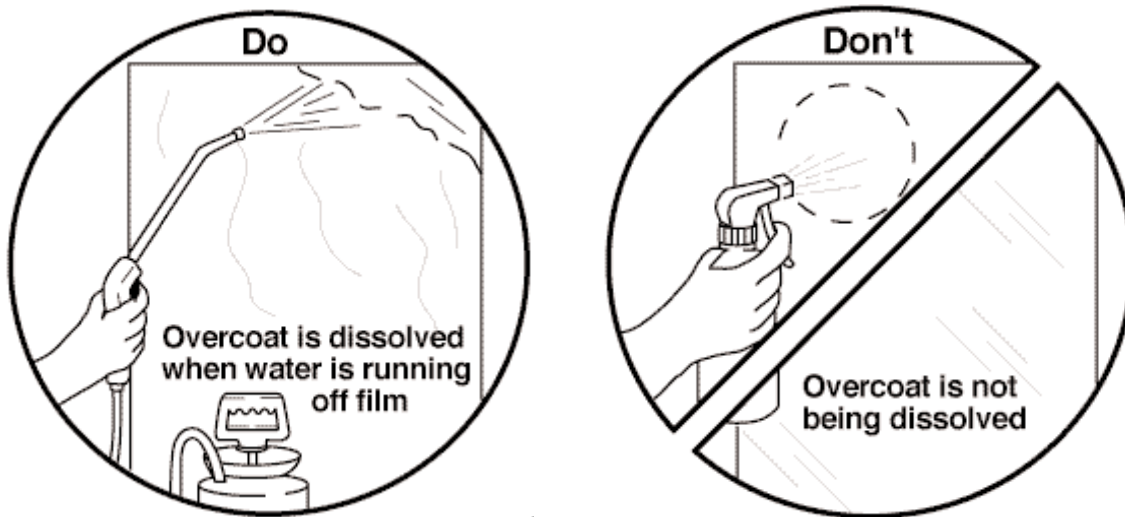

- V. Wash Fingers.
- VI. Turn Film Around and Apply to Glass.
 - A. Position right side and top, leaving 1/8" (3mm) border.
 - B. If window is not square, all edges might need trimming.

Film Application (continued)

VII. First Squeegee.

A. Use proper squeegee

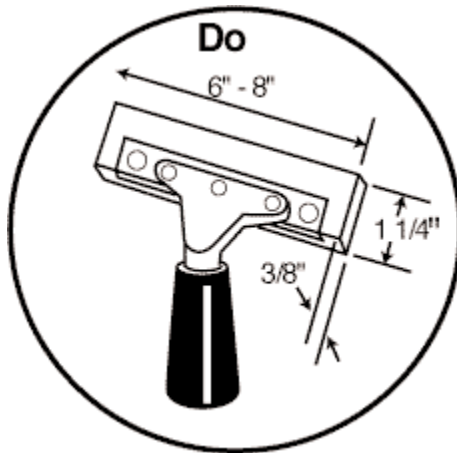

B. Lightly spray film surface.

C. Use proper squeegee pattern.

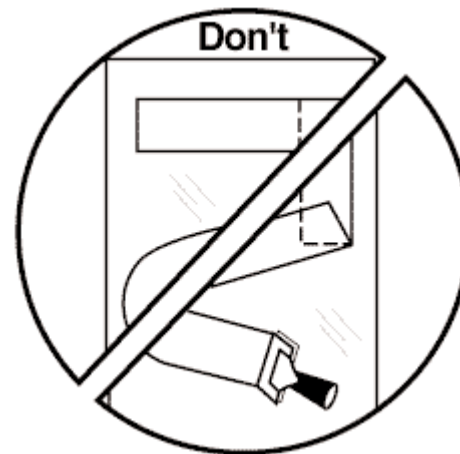
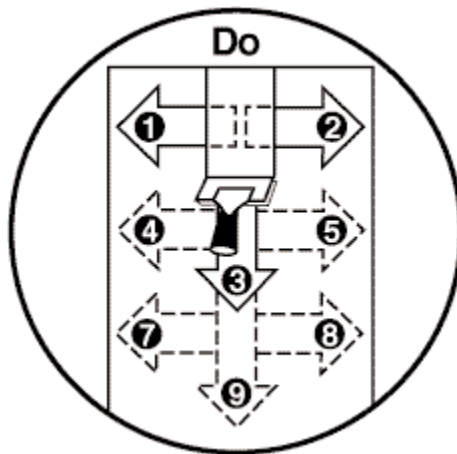

D. Always keep squeegee blade lubricated during squeegeeing.

Film Application (continued)

VIII. Trim Film to Size

- A. Use trimming guide.
- B. Trim within 1/8" (3mm) of window edge.
 - 1. Water removal
 - 2. Reduce dirt entrapment at edge
 - 3. Prevent edge damage
 - 4. Prevent edge corrosion
- C. Always use new blade tip after 3-4 cuts.

IX. Relubricate with Slip Solution and Squeegee (Using Squeegee and Squeegee Pattern Mentioned Above) Until All Water is Removed..

X. Dry Edges (Bumping).

- A. Bump film edge with absorbent lint-free towel wrapped around edge of Five-Way tool.
- B. Wipe frame edge dry.

Splicing

- Position and direction of splice must be determined by salesperson and customer prior to film installation.
- Leave instructions with customer that window washers should be aware of splice and squeegee window from direction of film that is on top.
- Always match factory edge to factory edge - Mark edge with masking tape.

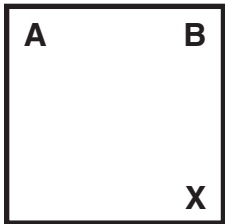

Not Correct

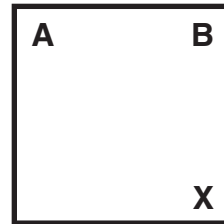
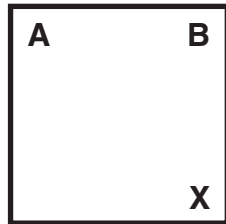

Correct

Overlap Splice

1. Overlap splice pieces about 1" (25 mm) and draw back to 1/8" (3 mm)
 - a. Horizontal splice - Upper piece over lower
 - b. Vertical - Left-hand piece over right-hand piece
2. Slowly squeegee parallel to overlap splice - lubricate film as required
3. Squeegee out maximum amount of water
4. Always use overlap splice for Safety and Security films (overlap splice must be 1/8" - 1/4" (3-6 mm))

Butt Splice/Cut Through Splice

1. Overlap film pieces 1" (25 mm)
2. With new sharp blade and a straight edge, cut through both pieces in exact center of overlap

NOTE: Use a new blade for each and every splice cut

3. Remove small piece from top, lift corner of bottom panel and remove lower smaller piece (spray water on splice during this process)
4. Slowly squeegee parallel to splice - lubricate as required
5. Squeegee out maximum amount of water

Why Edge Seal?

1. Protect edges from moisture
2. Prevent corrosion
3. Protect during washing
4. Helps protect against vandalism

NOTE: Edge sealing is a MUST for ALL external film applications or no warranty claim will be accepted

How To Edge Seal

1. Use 3M Clear Auto Sealer (part #08551). Available through automotive paint and body equipment suppliers
2. Surface must be clean and dry
3. Apply with small paint brush or cotton swab
4. Avoid sealant running down surface of film

Important Details About Your Installation Of 3M™ Scotchtint™ Film

Dear Customer:

Congratulations! You have just purchased the finest sun control product available. 3M has devoted 30 years to the development and improvement of Scotchtint film so that today you may enjoy the sun without experiencing the full effects of its harmful rays.

As with all products containing an adhesive system, a drying time is necessary to the achievement of the proper bond to the window. During this process, some changes may be observed. So that you will understand these differences, we would like to note some of them for you. They are normal and should be expected to occur. Listed below, by way of recap, are the points covered by our sales representative.

- Drying time will be approximately 30 days. Please do not wash your windows during this period.
- Any haziness you may see is water under the film. You will see less and less of this as the days pass.
- A milky appearance might be experienced, but it too disappears during the drying period.
- All water bubbles will dry out, but a few small particles or points may be apparent when dry. These points, generally seen from the outside, are very tiny and are inherent in the use of a pressure sensitive adhesive system. An adhesive of this type is used because it is the only one that will withstand high humidity, driving rains and window condensation. You will normally see these particles only if you get quite close to the glass, which is something we ordinarily do not do. They will not affect the film's performance.

The 1/8" (3 mm) border you notice is a requirement of the application according to 3M.

- Cleaning should be done using normal household window cleaners* or any non-abrasive window cleaning solution and wiping with a soft towel or squeegee. Paper towels or natural sponges should not be used.

NOTE: Sometimes a customer feels he sees a defect in the film when it is, in fact in the glass. It is quite natural that one should look closely at a new purchase, but at times we observe things that were always there but never noticed. A good rule to follow is to look at the installation from six feet away. This is the manner in which we normally look through a window and the way in which you should observe your Scotchtint film — looking through it, not at it

We and 3M hope you will enjoy your installation. With proper care, we know you will receive many years of benefit from its presence on your windows.

Very truly yours,

Authorized Dealer/Applicator
3M Specified Construction Products

*See warranty for cleaning instructions

Care and Cleaning Instructions for 3M™ Films

1. CARE MUST TAKEN NOT TO SCRATCH THE FILM, DO NOT USE BRISTLE BRUSHES OR ABRASIVE CLEANING MATERIALS
2. Household window cleaning solutions, such as Windex, are recommended
3. A soft cloth or clean synthetic sponge is recommended for washing. Do not use the same towel or sponge for wiping sills or frames. Paper towels or newspapers not recommended
4. A soft squeegee is recommended for removal of cleaning solution from the film
5. Do not apply heavy pressure in any cleaning operation
6. TIPS:
 - a. Additional caution is recommended when cleaning spliced areas. Clean in the direction of the splice
 - b. Do not leave the film wet
 - c. Make sure you use a different sponge, cleaning cloth and water bucket for cleaning the outside and the inside of the windows
 - d. Use a little extra detergent for cleaning Scotchtint film — it gives more ease to squeegeeing

THIS GLASS
HAS RECENTLY BEEN TREATED WITH
3M™ SCOTCHTINT™ WINDOW FILM .
THIS PRODUCT IS DESIGNED TO REDUCE
THE SUN'S HEAT AND GLARE. IN ORDER FOR IT
TO FUNCTION PROPERLY AND ACHIEVE ITS DESIRED

DO NOT WASH!

APPEARANCE, IT MUST CURE OUT FOR 30 DAYS.
PLEASE DO NOT WASH THESE WINDOWS OR REMOVE
THIS NOTICE UNTIL _____.

IF YOU HAVE ANY QUESTIONS, PLEASE CALL

Film Removal

1. Lift edge and try to pull off in sheets
2. If film is wider than 1' to 2' (30 to 60 cm), carefully cut into 1' to 2' (30 to 60 cm) strips

OR

3. Spray solution of ammonia and water onto film
4. Apply plastic film or newspaper on film
5. After one to two hours of soaking, lift edge and pull off in sheets
6. Clean adhesive residue with scraper using solution of ammonia and water

Application Do's

1. **Do** apply film on clean glass
 - a. Better application
 - b. Use 3M™ Scotch brand Magic Mending Tape to test for adhesion
2. **Do** use a sufficient amount of positioning solution during application
 - a. Wash off overcoat
 - b. Cleaner application
3. **Do** use plastic or stainless steel pressure spray tanks
 - a. More consistent cleaner applications
4. **Do** use plenty of new sharp blades during cutting and trimming
 - a. Less fingers
 - b. Film lays down better
5. **Do** apply film on entire surface of glass
 - a. Partial application can cause breakage (added stress)
 - b. No glass breakage warranty on partial applications
6. **Do** squeegee out the maximum amount of water
 - a. Less drying time
 - b. Better adhesion
 - c. Better overall performance and visual appearance
7. **Do** allow 1/8" (3 mm) border between film and molding
 - a. Water removal
 - b. Reduce dirt entrapment at edge
 - c. Reduce edge damage
 - d. Reduce edge corrosion
8. **Do** apply film on clean glass
 - a. Protect against elements
 - b. Reduce edge corrosion
 - c. No warranty if not edge sealed
9. **Do** use absorbent lint-free towels
 - a. Cleaner application

Application Don'ts

1. **Don't** use too much slip/positioning solution concentrate in the mixture with water
 - a. Less adhesion
 - b. More fingers
2. **Don't** use steel pressure spray tanks
 - a. Rust between film and glass
3. **Don't** install film when outside temperature is less than 40°F (5°C)
 - a. Longer drying times
 - b. Poor adhesion
4. **Don't** use silicone polish after installation
 - a. No emissivity with 3M™ Scotchtint™ Plus films
5. **Don't** add alcohol or other additives to slip/positioning solutions
 - a. Detackifies adhesive
 - b. Adhesive failure
6. **Don't** use double application of films
 - a. Heat build-up - glass breakage
 - b. Lack of adhesion
 - c. Longer drying times
7. **Don't** apply film on plastics
 - a. Heat and light cause outgassing
 - b. Bubbles occur
 - c. Can't remove adhesive
8. **Don't** apply film to chipped, broken or damaged glass
 - a. No warranty
9. **Don't** apply films onto glass on restricted list without submitting Glass Breakage Checklist
 - a. No warranty
10. **Don't** apply film in building under construction
 - a. High dust/dirt level
 - b. Drying time with temperature differences

AUTOMOTIVE TOOLS AND EQUIPMENT

Recommended Tools And Supplies

Having the proper tools and supplies for vehicle tint applications is extremely important, not only in quality of the installation, but productivity as well.

1. Cutting/Trimming Tool

- a. Choose the most comfortable
- b. Most widely used have replacement break-away blades
- c. Stainless blade is recommended over standard steel
 1. Will not scratch glass if proper pressure is applied
 2. Will lose sharpness quicker, so never use same tip for more than three cuts

2. Window Cleaning Scrappers

- a. One inch (25mm) for smaller windows
- b. Four inches (100mm) for most others
- c. Use amber color replacement blade for 4" (100mm) scraper - softer metal to conform better to curved glass

3. Trimming Guides

- a. 5-Way tool (whole or cut-a-way)
- b. Curved
- c. Triangle with hole cutting guide

4. Application Squeegees

- a. Black tube type (Smoothie Squeegee) - most popular
- b. Cut-A-Way 5-way tool with absorbent towel - to remove maximum amount of water

5. Window Cleaning Squeegee

- a. Good for cleaning windows
- b. Not good for applying film

6. Absorbent Towels

- a. Need absorbency and lint free

7. Pressure Spray Tank and Hand Spray Bottle

- a. Always use plastic or stainless steel containers instead of galvanized steel to prevent rust from coming between film and glass
- b. Three-gallon (11 liters) pressure spray is best
 1. More volume of water
 2. More pressure to flush away dirt and dust
 3. Larger spray pattern
 4. Save time during application
 5. Less physical activity
 6. Save time refilling
- c. Three-gallon (11 liters) replacement spray nozzle

1. Contains plastic in-line filter
2. Best spray pattern for cleaning and film application
- d. Install in-line filter onto hose of three-gallon (11 liters) pressure sprayer
 1. Use a clear casing to see amount of contamination from water supply
 2. Change often
- e. Do not add to water in tank. Empty tank and refill with clean water

8. Slip/Positioning Solution

- a. Recommend product for use in the slip solution is Joy dishwashing liquid or 3M.
- b. The use of other types of detergents may cause poor adhesion
- c. Proper slip solution ratio is 5 drops/gallon (3.8 liter)
- d. Too high a concentration level causes:
 1. Adhesive to detackify
 2. More fingers
 3. Film not to lay down properly

9. Adhesive Remover

- a. 3M™ Glass Cleaner - available through Authorized 3M™ Scotchtint™ film Distributor
- b. Use 00 steel wool or White 3M™ Scotch-brite™ pad when cleaning glass with heater lines

10. Fluorescent Light

- a. Provides light to shine through glass and film when cutting patterns
- b. Cooler light:
 1. Easy on eyes
 2. Will not burn interior of vehicle

11. "Don't Roll Down Window" Notice or Stickers

- a. Place onto switches for electric windows or on roll-down window handles
- b. Reminds customers not to roll down window for 3 - 5 days

Optional

1. Heat Gun - for one piece (few piece) rear windows
2. Cutting Table
3. Heat Lamps

AUTOMOTIVE PROCESS

Vehicle Application Recommendations

“Take the proper amount of time and care up front to maintain a high quality dirt-free application, rather than lose production time because of redo’s.”

1. Have tools and supplies close to vehicle - saves production time
2. Clean inside of window
 - a. Scrape
 - b. Rinse
 - c. Squeegee
3. Clean outside of window to eliminate dust/dirt coming into contact with film
4. Cut film pattern
 - a. Get film to conform to curvature of glass
 - b. Trim away excess film
 - c. Always break off blade after 3 cuts. Improperly cut edges will cause film to not lay down, or excessive fingers
5. Clean outside window again and leave a layer of water on glass to hold the film in place
6. Wash away water soluble overcoat as liner is being pulled off
7. Using the slip/positioning solution we the inside of the window

REMEMBER!! The more water between the film and the glass prior to squeegeeing, the cleaner the final application will be

8. Place the film on the inside of the vehicle window and squeegee out the maximum amount of water. To remove water from edge of window use a squeegee with an absorbent towel covering the squeegee blade.

HELPFUL HINTS

1. You **can't** use too much water
2. You **can** use too much slip/positioning solution
3. You **can't** use too many blades
4. You **never** use silicone near adhesives
5. Always rinse and squeegee off any window cleaning solutions or adhesive removers prior to film application
6. Always start squeegeeing from behind a finger and squeegee completely to edge of film

7. If film will not lay down, or you are experiencing excessive fingers, possible causes are:
 - a. Using improper slip/positioning solution with too much solvent or alcohol
 - b. Slip/positioning concentration too high
 - c. Edge of film cut with dull blade
 - d. Film cut too close to edge of window
 - e. Overcoat not completely washed (dissolved) off
 - f. Non-sticky substance on glass
8. Remove all decal's
9. If too much dust/dirt is behind film and glass, possible causes are:
 - a. Overcoat not completely washed (dissolved) off
 - b. Not enough water was used
10. Use fluorescent light inside of vehicles when cutting pattern from outside
11. Always apply "Don't Roll Down" stickers on roll-down windows with film
12. Apply narrow piece of masking tape over fuzzy channel material on framed side windows - reduces amount of dust/dirt on glass
13. Rinse your fingers prior to touching adhesive system
14. Always apply film below rubber molding on bottom of roll-down windows
15. When relief cutting, always cut twice the length of the finger
16. Always squeegee film on the flattest area of the glass first, then work toward the sides, and then the corners

Color-Stable Installation Techniques

VOLUME 1, ISSUE 1

FRIDAY, FEBRUARY 14,

Because of its unique construction, Color-Stable feels and handles somewhat differently than conventional window films. Following are a few techniques that will make difficult installations seem easier.

Heat Shrinking

- Thoroughly clean the outside surface of the window to which the film will be heat formed.
- From a 40" roll, cut the film to cover the width of the glass. Place the film so that it is in the machine direction. Leave a 1-inch overlap on the sides and 4 inches on the top and bottom. You'll need the extra film with this technique.
- Spray the mounting solution to the clean surface of the glass and apply the piece of film to be heat formed. Make sure the liner is towards you.
- Position the film on the window and squeegee making an H pattern to hold film in place on the glass. Do not form fingers, but make sure all excess film is at the top and bottom of the film, not the sides.

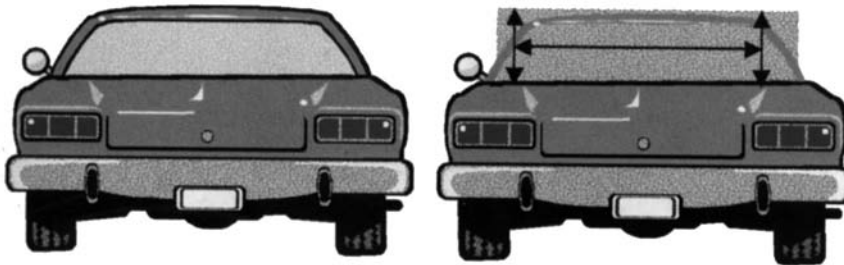

- Make a relief cut. Four inches from the top of the glass start cutting 1 inch from the dot matrix.

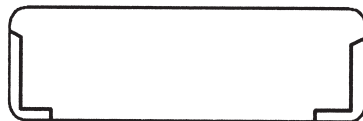

INSIDE THIS ISSUE:

H Pattern	1
Release Cut	1
Heat Forming	2
Walking The Dog	2
Horns & Fingers	2
High Tension Spots	2

SPECIAL POINTS OF INTEREST:

- *Color-Stable is actually thicker than most regular dyed films (1.1 mil), but a lot more pliable.*
- *Because of its maneuverability, it actually forms better to the dot matrix less silvering.*
- *No interference with satellite signals or worries with back-glass antennas.*
- *Never turns purple.*
- *3M is the only window film manufacturer capable of making this product from start to finish.*

3M Center Building 223-2S-24
St. Paul, MN 55144-1000

Email: ajoliva@mmm.com

Ideas that Stick!

**Color-Stable Bronze
Coming Soon!**

- Turn heat gun on to high and with your free hand, hold and lift the film at the top of the car, approximately 1 inch from the glass. You should now have created an air pocket. Horns will form around the pocket, commence heating the horns by fanning your heat gun with a side-to-side motion (5" from one side to the other). You'll notice that the film needs less heat to shrink; we recommend you hold the gun 4" from the film. After the horns disappear, start applying heat to the pocket.
- Once you have the film at the right temperature, you'll notice the pocket will melt rapidly (much faster than conventional films) and take the shape of the glass. Follow it until it disappears and then squeegee out with the 3M Gold Card. Do this for all the excess film on the top and bottom of the glass.
- For the extra film in the center area of the glass, you need to "walk the dog." Apply moderate heat (use the same fanning motion) to the film bubble and follow the air pocket until it is eliminated. Once eradicated, squeegee out with 3M Gold Card. Never lift the film in the center area or try to eliminate an air pocket that is horizontal.
- If you come across a high-tension area, you will notice that this film is a lot more forgiving than conventional films. Just apply opposite tension and moderate heat to the affected area.
- Once all of the excess film has been shrunk, the film can be removed from the glass and installed after normal cleaning procedures for the internal glass have been completed.

3M *Innovation*

Color-Stable film installation is similar to any other window film installation, the more you practice, the easier it becomes.

Be patient, with a little practice, you'll notice how much easier and quicker it is to apply Color-Stable Automotive Window Films.



Specifications

Scotchtint™

Prestige Sun Control Window Film

Scotchtint™

Sun Control Window Film

Scotchtint™

Night Vision Window Film

Scotchtint™ Plus

All Season Low E Window Film

Scotchtint™

Color-Stable Window Film

Scotchshield™

Ultra High Performance
Safety and Security Window Film

Scotchshield™

Safety and Security Window Film SH7CLARL

Scotchshield™

Safety and Security Window Film SH8CLARL

Scotchshield™

Safety and Security Window Film SH14CLARL

Specifications For 3M™ Prestige Window Film

1.0 Scope

This specification is for an abrasion resistant solar control window film which when applied to the interior window surface will reduce the gain of solar heat energy through the window. The film shall contain no metals. The film shall be called 3M* Prestige Sun Control Window Film _____.

2.0 Applicable Documents

The publications listed below form a part of this specification to the extent referenced. The publications are referred to in the text by the basic designation only.

The 1997 American Society for Heating, Refrigeration, and Air Conditioning Engineers (ASHRAE) Handbook of Fundamentals.

The American Society for Testing and Materials (ASTM) publication:

ASTM E-308 Standard Recommended Practice for Spectrophotometry and Description of Color in CIE 1931 System

ASTM E-903 Standard Methods of Test for Solar Absorbance, Reflectance and Transmittance of Materials Using Integrating Spheres

ASTM D-1044 Standard Method of Test for Resistance of Transparent Plastics to Surface Abrasion (Taber Abrader Test)

ASTM G-26 Standard Practice for Performing Accelerated Outdoor Weatherizing for Non-metallic Materials Using Concentrated Natural Sunlight

ASTM E-84 Standard Method of Test for Surface Burning Characteristics of Building Materials

Window 5.2, A Computer Tool for Analyzing Window Thermal Performance, Lawrence Berkeley Laboratory

3.0 Requirements of the Film

- 3.1 **Film Material:** The film shall be an optically clear polyester film containing at least 220 layers and incorporating an acrylic pressure sensitive adhesive on one side and an acrylic abrasion resistant coating on the other. The film shall also incorporate Infrared absorbing carbon and/or metal oxide particles. The film shall be uniform without noticeable pin holes, streaks, thin spots, scratches, banding or other optical defects. The variation in total transmission across the width, at any portion along the length, shall not exceed 2% over the average. The film shall have a nominal thickness of 2.0 mils (0.002 inches). There shall be no evidence of coating voids. The film shall be identified as to Manufacturer of Origin (hereafter to be called Manufacturer).
- 3.2 **Emissivity:** The emissivity of the non-adhesive surface of the film shall be 0.78 nominal when measured using a Devices & Services Emissometer Model AE at or near room temperature. The Manufacturer shall provide laboratory data of

emissivity and calculated window "U" Values for various outdoor temperatures based upon established calculation procedure defined by the 1997 ASHRAE Handbook of Fundamentals, ch. 29, or Lawrence Berkeley Laboratory Window 5.2 Computer Program available from:
<http://windows.lbl.gov/software/window/windo/html>.

- 3.3 **U Value:** The U Value of the film applied to 1/4" (6mm) clear glass shall be 1.0 nominal when measured in accordance with test procedures described in 3.2 for Emissivity.
- 3.4 **Transmission - Visible:** When applied to 1/4" (6mm) clear glass, the luminous transmittance shall be _____ nominal when measured with an integrating sphere spectrophotometer as referenced by ASTM E-903 and calculated per ASTM E-308 using Standard Source "C" for average daylight.
- 3.5 **Reflection – Visible, Exterior:** When applied to 1/4" (6mm) clear glass, the total luminous reflection from the glass surface shall be _____ nominal when measured with an integrating sphere spectrophotometer as referenced by ASTM E-903 and calculated per ASTM E-308 using Standard CIE Source "C" for average daylight.
- Reflection – Visible, Interior:** When applied to 1/4" (6mm) clear glass, the total luminous reflection from the glass surface shall be _____ nominal when measured with an integrating sphere spectrophotometer as referenced by ASTM E-903 and calculated per ASTM E-308 using Standard CIE Source "C" for average daylight.
- 3.6 **Rejected - Ultraviolet Light:** When applied to 1/4" (6mm) clear glass, the total transmission of solar ultraviolet radiation of air mass = 2 over the spectral range of 3000 to 3800 angstroms shall be 99.9% minimum when measured with an integrating sphere spectrophotometer as referenced by ASTM E-903.
- 3.7 **Rejected - Infrared Light:** Film shall have an IR transmission of not more than 3% when measured between 900-1000 nanometers.
- 3.8 **Luminous Efficacy:** When applied to 1/4" (6mm) clear glass, the luminous efficacy (Defined as the ratio of visible light transmission to shading coefficient) shall be _____ Nominal.
- 3.9 **Shading Coefficient:** When applied to 1/4" (6mm) clear glass, the shading coefficient shall be _____ nominal (_____ at 60 Degrees) as measured per ASTM E-903 and computed in accordance with the established procedures defined by The ASHRAE Handbook of Fundamentals.
- 3.10 **Adhesive System:** The film shall be supplied with an optically clear pressure sensitive weather able acrylic adhesive applied uniformly over the surface opposite the abrasion resistant coating.
- 3.11 **Flammability:** The Manufacturer shall provide independent test data showing that the window film shall meet the requirements of a Class A Interior Finish for Building Materials for both Flame Spread Index and Smoke Development Values per ASTM E-84.
- 3.12 **Abrasion Resistance:** The Manufacturer shall provide independent test data showing that the film shall have a surface coating that is resistant to abrasion such

that, less than 5% increase of transmitted light haze will result in accordance with ASTM D-1044 using 50 cycles, 500 grams weight, and the CS10F Calbrase Wheel.

4.0 Requirements of the Authorized Dealer/Applicator (ADA)

- 4.1 The ADA shall provide documentation that the ADA is authorized by the Manufacturer to install window film as per the Manufacturer's specifications and in accordance with specific requests as to be determined and agreed to by the customer.
- 4.2 Authorization of dealership may be verified through the company's 3M I.D. Number.
- 4.3 The ADA will provide a commercial building reference list of ____ (#) properties where the ADA has installed window film. This list will include the following information:
 - * Name of building
 - * The name and telephone number of a management contact
 - * Type of glass
 - * Type of film
 - * Amount of film installed
 - * Date of completion
- 4.4 Upon request, the ADA will provide a Glass Stress Analysis of the existing glass and proposed glass/film combination as recommended by the film Manufacturer.
- 4.5 Upon request, the ADA will provide an application analysis to determine available energy cost reduction and savings.
- 5.0 Requirements of the Manufacturer
- 5.1 The Manufacturer will insure proper quality control during production, shipping and inventory, clearly identify and label each film core with the product designation and run number.
- 5.2 Materials shall be manufactured by:
 - 3M Building Safety Solutions Department (BSSD)
 - 3M Center Building 223-2S-24
 - St. Paul, MN 55144-1000
- 5.3 3M BSSD Point of Contact:

Michael Hassenauer, 651-737-1053

6.0 Application

- 6.1 **Examination:** Examine glass surfaces to receive new film and verify that they are free from defects and imperfections which will affect the final appearance. Correct and/or note all such deficiencies to the owner prior to commencing film application.

6.2 Preparation:

- a. The use of protective tarps and/or drop cloths to cover office interior furnishing near the window is a recommended practice.
- b. The window and window framing will be cleaned thoroughly with a neutral cleaning solution. The inside surface of the window glass shall be bladed with industrial razors to insure the removal of any foreign contaminants.
- c. Toweling or other absorbent material shall be placed on the window sill or sash to absorb moisture generated by the film application process.

6.3 Installation: The film shall be applied as to the specifications of the Manufacturer by an ADA.

- a. Materials will be delivered to the job site with the manufacturer's labels intact and legible.
- b. Film edges shall be cut neatly and square at a uniform distance of 1/8" (3mm) to 1/16" (1,5mm) of the window sealing device.
- c. Edge Seal – None required. 3M Prestige Window Film do not contain metals.
- d. Water and film slip solution only will be used on the window glass and adhesive to facilitate the proper positioning of the film.
- e. To insure efficient removal of excess water from the underside of the film and to maximize bonding of the pressure sensitive adhesive, polyplastic bladed squeegees will be utilized.
- f. Upon completion, the film may have a dimpled appearance from residual moisture. Said moisture shall, under reasonable weather conditions, dry flat with no moisture dimples within a period of 30 calendar days when viewed under normal viewing conditions.
- g. After installation, any left over material and/or debris will be removed and the work area will be returned to original condition. Use all necessary means to protect the film before, during and after the installation.

7.0 Cleaning

The film may be washed using common window cleaning solutions, including ammonia solutions, 30 days after application. Abrasive type cleaning agents and bristle brushes which could scratch the film must not be used. Synthetic sponges or soft cloths are recommended.

8.0 Warranty

Films Covered: Prestige 70, Prestige 60, Prestige 50 & Prestige 40.

- 8.1 The application shall be warranted by the film manufacturer (3M) for a period of Fifteen (15) years in that the film will maintain solar reflective properties without cracking, crazing, delaminating, bubbling, peeling or discoloration. In the event

that the product is found to be defective under warranty, the seller will replace such quantity of the film proved to be defective, and will additionally provide the removal and reapplication labor free of charge.

- 8.2 The film manufacturer (3M) also warrants against glass failure (maximum value \$500 per window) due to thermal shock fracture of glass provided the film is applied to recommended types of glass and the failure occurs within sixty (60) months from the start of application. Any glass failure must be reviewed by the film manufacturer (3M) prior to replacement.

Title	3M	Prestige	Window	Films
1.0 Scope (Prestige Films)	PR 70	PR 60	PR 50	PR 40
3.1 Thickness				
(mils)	>2.0	>2.0	>2.0	>2.0
(inches)	0.0020	0.0020	0.0020	0.0020
3.2 Emissivity	0.78	0.78	0.78	0.78
3.3 U Value	0.99	0.99	0.99	0.99
3.4 Visible Light Transmission	68%	61%	50%	39%
3.5 Visible Reflection – Exterior	9%	8%	8%	7%
Visible Reflection – Interior	9%	8%	7%	6%
3.6 Ultraviolet Rejected	>99.9%	>99.9%	>99.9%	>99.9%
3.7 Infrared Energy Rejected	97%	97%	97%	97%
3.8 Luminous Efficacy	1.17	1.11	0.98	0.83
3.9 Shading Coefficient – at 90 Degrees (normal incidence)	0.58	0.55	0.51	0.47
3.9.1 Total Solar Energy Rejected at 90 Degrees (normal incidence)	50%	52%	56%	59%
3.9.2 TSER – 60 Degree Angle	59%	61%	63%	66%

Note: Performance based upon 1/4" clear glass

Specifications For Sun Control Window Film

1.0 Scope

This specification is for an abrasion resistant solar control window film which when applied to the interior window surface will reduce the gain of solar heat energy through the window. The film shall be called 3M™ Scotchtint™ Sun Control Window Film _____.

2.0 Applicable Documents

The publications listed below form a part of this specification to the extent referenced. The publications are referred to in the text by the basic designation only.

The 1985 American Society for Heating, Refrigeration, and Air Conditioning Engineers (ASHRAE) Handbook of Fundamentals.

The American Society for Testing and Materials (ASTM) publication:

ASTM E-308 Standard Recommended Practice for Spectrophotometry and Description of Color in CIE 1931 System

ASTM E-903 Standard Methods of Test for Solar Absorbance, Reflectance and Transmittance of Materials Using Integrating Spheres

ASTM D-1044 Standard Method of Test for Resistance of Transparent Plastics to Surface Abrasion (Taber Abrader Test)

ASTM G-90 Standard Practice for Performing Accelerated Outdoor Weatherizing for Non-metallic Materials Using Concentrated Natural Sunlight

ASTM E-84 Standard Method of Test for Surface Burning Characteristics of Building Materials

Window 4.0, A Computer Tool for Analyzing Window Thermal Performance, Lawrence Berkeley Laboratory

3.0 Requirements of the Film

- 3.1 **Film Material:** The film material shall be an optically clear metallized polyester film which may be laminated to a clear polyester film. There must be an acrylic abrasion resistant coating over the surface of the film for enhanced durability. The film color is derived from a metal coating and the product will not contain dyed polyester. The metallic coating shall be uniform without noticeable pin holes, streaks, thin spots, scratches or banding. The variation in total transmission across the width, at any portion along the length, shall not exceed 2% over the average. The film shall have a nominal thickness of _____ mils (_____ inches). The density of the film across the web is not to exceed plus or minus 2%. There shall be no evidence of coating voids. The film shall be identified as to Manufacturer of Origin (hereafter to be called Manufacturer).
- 3.2 **Emissivity:** The emissivity of the non-adhesive surface of the film shall be _____ nominal when measured using a Devices & Services Emissometer Model AE at or near room temperature. The Manufacturer shall provide laboratory data of emissivity and calculated window "U" Values for various outdoor temperatures based upon established calculation procedure defined by the 1985 ASHRAE Handbook of Fundamentals, ch. 27, or Lawrence Berkeley Laboratory Window 4.0 Computer Program.
- 3.3 **U Value:** The U Value of the film applied to 1/4" (6mm) clear glass shall be _____ nominal when measured in accordance with test procedures described in 3.2 for Emissivity.
- 3.4 **Transmission - Visible:** When applied to 1/4" (6mm) clear glass, the luminous transmittance shall be _____ nominal when measured with an integrating sphere spectrophotometer as referenced by ASTM E-903 and calculated per ASTM E-308 using Standard Source "C" for average daylight.
- 3.5 **Reflection - Visible:** When applied to 1/4" (6mm) clear glass, the total luminous reflection from the glass surface shall be _____ nominal when measured with an integrating sphere spectrophotometer as referenced by ASTM E-903 and calculated per ASTM E-308 using Standard CIE Source "C" for average daylight.

- 3.6 **Transmission - Ultraviolet Light:** When applied to 1/4" (6mm) clear glass, the total transmission of solar ultraviolet radiation of air mass = 2 over the spectral range of 3000 to 3800 angstroms shall not exceed _____ when measured with an integrating sphere spectrophotometer as referenced by ASTM E-903.
- 3.7 **Shading Coefficient:** When applied to 1/4" (6mm) clear glass, the shading coefficient shall be _____ nominal when solar energy transmittance and reflection are measured per ASTM E-903 and the shading coefficient is computed in accordance with the established procedures defined by The ASHRAE Handbook of Fundamentals.
- 3.8 **Adhesive System:** The film shall be supplied with a pressure sensitive weatherable acrylate adhesive applied uniformly over the surface opposite the abrasion resistant coating. A water soluble detackifier shall be incorporated over the pressure sensitive adhesive to facilitate handling. The adhesive shall be essentially optically flat and shall meet the following criteria:
- a. Viewing the film from a distance of ten feet (3 m) at angles up to 45 degrees from either side of the glass, the film itself shall not appear distorted.
- 3.9 **Flammability:** The Manufacturer shall provide independent test data showing that the window film shall meet the requirements of a Class A Interior Finish for Building Materials for both Flame Spread Index and Smoke Development Values per ASTM E-84.
- 3.10 **Abrasion Resistance:** The Manufacturer shall provide independent test data showing that the film shall have a surface coating that is resistant to abrasion such that, less than 5% increase of transmitted light haze will result in accordance with ASTM D-1044 using 100 cycles, 500 grams weight, and the CS10F Calbrase Wheel.

4.0 Requirements of the Authorized Dealer/Applicator (ADA)

- 4.1 The ADA shall provide documentation that the ADA is certified by the Manufacturer to install window film as per the Manufacturer's specifications and in accordance with specific requests as to be determined and agreed to by the customer.
- 4.2 Authorization of dealership may be verified through the company's 3M I.D. Number.
- 4.3 The ADA will provide a commercial building reference list of ten (10) properties where the ADA has installed window film. This list will include the following information:
- * Name of building
 - * The name and telephone number of a management contact
 - * Type of glass
 - * Type of film
 - * Amount of film installed
 - * Date of completion
- 4.4 Upon request, the ADA will provide a Glass Stress Analysis of the existing glass and proposed glass/film combination as recommended by the film Manufacturer.
- 4.5 Upon request, the ADA will provide an application analysis to determine available energy cost reduction and savings.

5.0 Requirements of the Manufacturer

- 5.1 The Manufacturer will insure proper quality control during production, shipping and inventory, clearly identify and label each film core with the product designation and run number.
- 5.2 The Manufacturer will, upon request and pre-approval, provide 100% financing for the complete installation of the window film to the end-user customer in either an installment purchase or lease purchase format to be decided upon by customer.
- 5.3 Materials shall be manufactured by:

3M Consumer Safety and Light Management Department
3M Center, Building 223-02-S-24
St. Paul, MN 55144-1000

6.0 Application

6.1 **Examination:** Examine glass surfaces to receive new film and verify that they are free from defects and imperfections which will affect the final appearance. Correct all such deficiencies before starting film application.

6.2 Preparation:

- a. The window and window framing will be cleaned thoroughly with a neutral cleaning solution. The inside surface of the window glass shall be bladed with industrial razors to insure the removal of any foreign contaminant's.
- b. Toweling or other absorbent material shall be placed on the window sill or sash to absorb moisture accumulation generated by the film application.

6.3 **Installation:** The film shall be applied as to the specifications of the Manufacturer by an ADA.

- a. Materials will be delivered to the job site with the manufacturer's labels intact and legible.
- b. To minimize waste, the film will be cut to specification utilizing a vertical dispenser designed for that purpose. Film edges shall be cut neatly and square at a uniform distance of 1/8" (3mm) to 1/16" (1,5mm) of the window sealing device.
- c. Clear, clean water will be used to remove the water soluble overcoat that protects the pressure sensitive adhesive. Water and film slip solution only will be used on the window glass to facilitate the proper positioning of the film.
- d. To insure efficient removal of excess water from the underside of the film and to maximize bonding of the pressure sensitive adhesive, polyplastic bladed squeegees will be utilized.
- e. Upon completion, the film may have a dimpled appearance from residual moisture. Said moisture shall, under reasonable weather conditions, dry flat with no moisture dimples within a period of 30 calendar days when viewed under normal viewing conditions.
- f. After installation, any left over material will be removed and the work area will be returned to original condition. Use all necessary means to protect the film before, during and after the installation.

7.0 Cleaning

The film may be washed using common window cleaning solutions, including ammonia solutions, 30 days after application. Abrasive type cleaning agents and bristle brushes which could scratch the film must not be used. Synthetic sponges or soft cloths are recommended.

8.0 Warranty

Scotchint Films Covered: P-18ARL, RE20NEARL, RE35NEARL, RE50NEARL, RE70NEARL and RE35AMARL

- 8.1 The application shall be warranted by the film manufacturer (3M) for a period of ten (10) years in that the film will maintain solar reflective properties without cracking, crazing, delaminating, bubbling, peeling or discoloration. In the event that the product is found to be defective under warranty, the seller will replace such quantity of the film proved to be defective, and will additionally provide the removal and reapplication labor free of charge.
- 8.2 The film manufacturer (3M) also warrants against glass failure due to thermal shock fracture of the glass and/or seal failure of the window unit (maximum value \$500 per window) provided the film is applied to recommended types of glass and the failure occurs within sixty (60) months from the start of application. Any glass failure or seal failure must be reviewed by the film manufacturer (3M) prior to replacement.

3M™ Sun Control Window Film

Title			
1.0	Scope	P-18ARL (Silver)	RE35AMARL (Amber)
3.1	Thickness		
	(mils)	1.5	1.5
	(inches)	0.0015	0.0015
3.2	Emissivity	0.65	0.68
3.3	U Value	0.95	0.95
3.4	Transmission - Visible	19%	30%
3.5	Reflection - Visible	58%	55%
3.6	Transmission - Ultraviolet	<1%	<1%
3.7	Shading Coefficient	0.26	0.30

Title					
1.0	Scope (Neutral)	RE20NEARL	RE35NEARL	RE50NEARL	RE70NEARL
3.1	Thickness				
	(mils)	2.0	1.0	1.0	1.0
	(inches)	0.0020	0.0010	0.0010	0.0010
3.2	Emissivity	0.84	0.84	0.84	0.84
3.3	U Value	1.06	1.06	1.06	1.06
3.4	Transmission - Visible	16%	37%	51%	66%
3.5	Reflection - Visible	17%	20%	15%	9%
3.6	Transmission - Ultraviolet	<1%	<1%	<3%	<5%
3.7	Shading Coefficient	0.39	0.51	0.66	0.76

Specifications For 3M™ Night Vision Window Films

1.0 Scope

This specification is for an abrasion resistant solar control window film which when applied to the interior window surface will reduce the gain of solar heat energy through the window. The film shall be called 3M™ Scotchtint™ Night Vision Window Film.

2.0 Applicable Documents

The publications listed below form a part of this specification to the extent referenced. The publications are referred to in the text by the basic designation only.

The 1985 American Society for Heating, Refrigeration, and Air Conditioning Engineers (ASHRAE) Handbook of Fundamentals.

The American Society for Testing and Materials (ASTM) publication:

ASTM E-308 Standard Recommended Practice for Spectrophotometry and Description of Color in CIE 1931 System

ASTM E-903 Standard Methods of Test for Solar Absorbance, Reflectance and Transmittance of Materials Using Integrating Spheres

ASTM D-1044 Standard Method of Test for Resistance of Transparent Plastics to Surface Abrasion (Taber Abrader Test)

ASTM G-90 Standard Practice for Performing Accelerated Outdoor Weatherizing for Nonmetallic Materials Using Concentrated Natural Sunlight

ASTM E-84 Standard Method of Test for Surface Burning Characteristics of Building Materials

Window 4.0, A Computer Tool for Analyzing Window Thermal Performance, Lawrence Berkeley Laboratory

3.0 Requirements of the Film

- 3.1 **Film Material:** The film material shall be an optically clear metallized polyester film which may be laminated to a clear polyester film. There must be an acrylic abrasion resistant coating over the surface of the film for enhanced durability. The film color is derived from a metal coating and the product will not contain dyed polyester. The metallic coating shall be uniform without noticeable pin holes, streaks, thin spots, scratches or banding. The variation in total transmission across the width, at any portion along the length, shall not exceed 2% over the average. The film shall have a nominal thickness of _____ mils (_____ inches). The density of the film across the web is not to exceed plus or minus 2%. There shall be no evidence of coating voids. The film shall be identified as to Manufacturer of Origin (hereafter to be called Manufacturer).
- 3.2 The emissivity of the non-adhesive surface of the film shall be _____ nominal when measured using a Devices & Services Emissometer Model AE at or near room temperature. The Manufacturer shall provide laboratory data of emissivity and calculated window "U" Values for various outdoor temperatures based upon established calculation procedure defined by the 1985 ASHRAE Handbook of Fundamentals, ch. 27, or Lawrence Berkeley Laboratory Window 4.0 Computer Program.
- 3.3 **U Value:** The U Value of the film applied to 1/4" (6mm) clear glass shall be _____ nominal when measured in accordance with test procedures described in 3.2 for Emissivity.
- 3.4 **Transmission - Visible:** When applied to 1/4" (6mm) clear glass, the luminous transmittance shall be _____ nominal when measured with an integrating sphere spectrophotometer as referenced by ASTM E-903 and calculated per ASTM E-308 using Standard Source "C" for average daylight.
- 3.5 **Reflection - Visible:** When applied to 1/4" (6mm) clear glass, the total luminous reflection from the glass surface shall be _____ nominal when measured with an integrating sphere spectrophotometer as referenced by ASTM E-903 and calculated per ASTM E-308 using Standard CIE Source "C" for average daylight.

- 3.6 **Transmission - Ultraviolet Light:** When applied to 1/4" (6mm) clear glass, the total transmission of solar ultraviolet radiation of air mass = 2 over the spectral range of 3000 to 3800 angstroms shall not exceed _____ when measured with an integrating sphere spectrophotometer as referenced by ASTM E-903.
- 3.7 **Shading Coefficient:** When applied to 1/4" (6mm) clear glass, the shading coefficient shall be _____ nominal when solar energy transmittance and reflection are measured per ASTM E-903 and the shading coefficient is computed in accordance with the established procedures defined by The ASHRAE Handbook of Fundamentals.
- 3.8 **Adhesive System:** The film shall be supplied with a pressure sensitive weatherable acrylate adhesive applied uniformly over the surface opposite the abrasion resistant coating. A water soluble detackifier shall be incorporated over the pressure sensitive adhesive to facilitate handling. The adhesive shall be essentially optically flat and shall meet the following criteria:
- a. Viewing the film from a distance of ten feet (3 m) at angles up to 45 degrees from either side of the glass, the film itself shall not appear distorted.
- 3.9 **Flammability:** The Manufacturer shall provide independent test data showing that the window film shall meet the requirements of a Class A Interior Finish for Building Materials for both Flame Spread Index and Smoke Development Values per ASTM E-84.
- 3.10 **Abrasion Resistance:** The Manufacturer shall provide independent test data showing that the film shall have a surface coating that is resistant to abrasion such that, less than 5% increase of transmitted light haze will result in accordance with ASTM D-1044 using 100 cycles, 500 grams weight, and the CS10F Calbrase Wheel.

4.0 Requirements of the Authorized Dealer/Applicator (ADA)

- 4.1 The ADA shall provide documentation that the ADA is certified by the Manufacturer to install window film as per the Manufacturer's specifications and in accordance with specific requests as to be determined and agreed to by the customer.
- 4.2 Authorization of dealership may be verified through the company's 3M I.D. Number.
- 4.3 The ADA will provide a commercial building reference list of ten (10) properties where the ADA has installed window film. This list will include the following information:
- * Name of building
 - * The name and telephone number of a management contact
 - * Type of glass
 - * Type of film
 - * Amount of film installed
 - * Date of completion
- 4.4 Upon request, the ADA will provide a Glass Stress Analysis of the existing glass and proposed glass/film combination as recommended by the film Manufacturer.
- 4.5 Upon request, the ADA will provide an application analysis to determine available energy cost reduction and savings.

5.0 Requirements of the Manufacturer

- 5.1 The Manufacturer will insure proper quality control during production, shipping and inventory, clearly identify and label each film core with the product designation and run number.
- 5.2 The Manufacturer will, upon request and pre-approval, provide 100% financing for the complete installation of the window film to the end-user customer in either an installment purchase or lease purchase format to be decided upon by customer.
- 5.3 Materials shall be manufactured by:

3M Consumer Safety and Light Management Department
3M Center, Building 223-02-S-24
St. Paul, MN 55144-1000

6.0 Application

6.1 **Examination:** Examine glass surfaces to receive new film and verify that they are free from defects and imperfections which will affect the final appearance. Correct all such deficiencies before starting film application.

6.2 Preparation:

- a. The window and window framing will be cleaned thoroughly with a neutral cleaning solution. The inside surface of the window glass shall be bladed with industrial razors to insure the removal of any foreign contaminant's.
- b. Toweling or other absorbent material shall be placed on the window sill or sash to absorb moisture accumulation generated by the film application.

6.3 **Installation:** The film shall be applied as to the specifications of the Manufacturer by an ADA.

- a. Materials will be delivered to the job site with the manufacturer's labels intact and legible.
- b. To minimize waste, the film will be cut to specification utilizing a vertical dispenser designed for that purpose. Film edges shall be cut neatly and square at a uniform distance of 1/8" (3mm) to 1/16" (1,5mm) of the window sealing device.
- c. Clear, clean water will be used to remove the water soluble overcoat that protects the pressure sensitive adhesive. Water and film slip solution only will be used on the window glass to facilitate the proper positioning of the film.
- d. To insure efficient removal of excess water from the underside of the film and to maximize bonding of the pressure sensitive adhesive, polyplastic bladed squeegees will be utilized.
- e. Upon completion, the film may have a dimpled appearance from residual moisture. Said moisture shall, under reasonable weather conditions, dry flat with no moisture dimples within a period of 30 calendar days when viewed under normal viewing conditions.
- f. After installation, any left over material will be removed and the work area will be returned to original condition. Use all necessary means to protect the film before, during and after the installation.

7.0 Cleaning

The film may be washed using common window cleaning solutions, including ammonia solutions, 30 days after application. Abrasive type cleaning agents and bristle brushes which could scratch the film must not be used. Synthetic sponges or soft cloths are recommended.

8.0 Warranty

Scotchint Films Covered: NV-15, NV-25, NV-35 and NV-45

- 8.1 The application shall be warranted by the film manufacturer (3M) for a period of ten (10) years in that the film will maintain solar reflective properties without cracking, crazing, delaminating, bubbling, peeling or discoloration. In the event that the product is found to be defective under warranty, the seller will replace such quantity of the film proved to be defective, and will additionally provide the removal and reapplication labor free of charge.
- 8.2 The film manufacturer (3M) also warrants against glass failure due to thermal shock fracture of the glass and/or seal failure of the window unit (maximum value \$500 per window) provided the film is applied to recommended types of glass and the failure occurs within sixty (60) months from the start of application. Any glass failure or seal failure must be reviewed by the film manufacturer (3M) prior to replacement.

3M™ Scotchtint™ Night Vision Window Film

Title

1.0	Scope	NV-15	NV-25	NV-35	NV-45
3.1	Thickness (mils)	2.5	2.5	2.5	2.5
3.2	Emissivity	0.70	0.72	0.74	0.78
3.3	U Value	1.04	1.05	1.06	1.06
3.4	Transmission - Visible	15%	25%	35%	45%
3.5	Reflection - Visible				
	interior	19%	13%	12%	8%
	interior	43%	29%	18%	8.4%
3.6	Transmission - Ultraviolet	<1%	<1%	<1%	<1%
3.7	Shading Coefficient	0.29	0.39	0.49	0.63

Specifications For 3M™ Plus All Season Low E Window Film

1.0 Scope

This specification is for an abrasion resistant Low E window film which when applied to the interior window surface will retard the flow of heat energy through the window. The film shall be called 3M™ Scotchtint™ Plus All Season Window Film _____.

2.0 Applicable Documents

The publications listed below form a part of this specification to the extent referenced. The publications are referred to in the text by the basic designation only.

The 1985 American Society for Heating, Refrigeration, and Air Conditioning Engineers (ASHRAE) Handbook of Fundamentals.

The American Society for Testing and Materials (ASTM) publication:

ASTM E-308 Standard Recommended Practice for Spectrophotometry and Description of Color in CIE 1931 System

ASTM E-903 Standard Methods of Test for Solar Absorbance, Reflectance and Transmittance of Materials Using Integrating Spheres

ASTM D-1044 Standard Method of Test for Resistance of Transparent Plastics to Surface Abrasion (Taber Abrader Test)

ASTM G-90 Standard Practice for Performing Accelerated Outdoor Weatherizing for Non-metallic Materials Using Concentrated Natural Sunlight

ASTM E-84 Standard Method of Test for Surface Burning Characteristics of Building Material

Window 4.0, A Computer Tool for Analyzing Window Thermal Performance,
Lawrence Berkeley Laboratory

3.0 Requirements of the Film

- 3.1 **Film Material:** The film material shall be an optically clear metallized polyester film laminated to a clear polypropylene film with a durable acrylic abrasion resistant coating over the polypropylene film which will provide a low emissivity surface. The film color is derived from a metal coating and the product will not contain dyed polyester. The metallic coating shall be uniform without noticeable pinholes, streaks, thin spots, scratches or banding. The film shall have a nominal thickness of _____ mils (_____ inches). The density of the film across the web is not to exceed plus or minus 2%. There shall be no evidence of coating voids. The film shall be identified as to Manufacturer of Origin (hereafter to be called Manufacturer).
- 3.2 **Emissivity:** The emissivity of the non-adhesive surface of the film shall be _____ nominal when measured using a Devices & Services Emissometer Model AE at or near room temperature. The Manufacturer shall provide laboratory data of emissivity and calculated window "U" Values for various outdoor temperatures based upon established calculation procedure defined by the 1985 ASHRAE Handbook of Fundamentals, ch. 27, or Lawrence Berkeley Laboratory Window 4.0 Computer Program.
- 3.3 **U Value:** The U Value of the film applied to 1/4" (6mm) clear glass shall be _____ nominal when measured in accordance with test procedures described in 3.2 for Emissivity.
- 3.4 **Transmission - Visible:** When applied to 1/4" (6mm) clear glass, the luminous transmittance shall be _____ nominal when measured with an integrating sphere spectrophotometer as referenced by ASTM E-903 and calculated per ASTM E-308 using Standard Source "C" for average daylight.
- 3.5 **Reflection - Visible:** When applied to 1/4" (6mm) clear glass, the total luminous reflection from the glass surface shall be _____ nominal when measured with an integrating sphere spectrophotometer as referenced by ASTM E-903 and calculated per ASTM E-308 using Standard CIE Source "C" for average daylight.

- 3.6 **Transmission - Ultraviolet Light:** When applied to 1/4" (6mm) clear glass, the total transmission of solar ultraviolet radiation of air mass = 2 over the spectral range of 3000 to 3800 angstroms shall not exceed _____ when measured with an integrating sphere spectrophotometer as referenced by ASTM E-903.
- 3.7 **Shading Coefficient:** When applied to 1/4" (6mm) clear glass, the shading coefficient shall be _____ nominal when solar energy transmittance and reflection are measured per ASTM E-903 and the shading coefficient is computed in accordance with the established procedures defined by The ASHRAE Handbook of Fundamentals.
- 3.8 **Adhesive System:** The film shall be supplied with a pressure sensitive weatherable acrylate adhesive applied uniformly over the surface opposite the low emissivity surface. A water soluble detackifier shall be incorporated over the pressure sensitive adhesive to facilitate handling. The adhesive shall be essentially optically flat and shall meet the following criteria:
- Viewing the film from a distance of ten feet (3 m) at angles up to 45 degrees from either side of the glass, the film itself shall not appear distorted.
 - It shall not be necessary to seal around the edges of the applied film system with a lacquer or other substance in order to prevent moisture or free water from penetrating under the film system.
- 3.9 **Flammability:** The Manufacturer shall provide independent test data showing that the window film shall meet the requirements of a Class A Interior Finish for Building Materials for both Flame Spread Index and Smoke Development Values per ASTM E-84.
- 3.10 **Abrasion Resistance:** The Manufacturer shall provide independent test data showing that the film has a surface coating that is resistant to abrasion such that, less than 5% increase of transmitted scattered light and haze will result in accordance with ASTM D-1044 using 100 cycles, 500 grams weight, and the CS10F Calbrase Wheel.
- 4.0 Requirements of the Authorized Dealer/Applicator (ADA)**
- 4.1 The ADA shall provide documentation that the ADA is certified by the Manufacturer to install window film as per the Manufacturer's specifications and in accordance with specific requests as to be determined and agreed to by the customer.
- 4.2 Authorization of dealership may be verified through the company's 3M I.D. Number.
- 4.3 The ADA will provide a commercial building reference list of ten (10) properties where the ADA has installed window film. This list will include the following information:
- * Name of building
 - * The name and telephone number of a management contact
 - * Type of glass
 - * Type of film
 - * Amount of film installed
 - * Date of completion
- 4.4 Upon request, the ADA will provide a Glass Stress Analysis of the existing glass and proposed glass/film combination as recommended by the film Manufacturer.
- 4.5 Upon request, the ADA will provide an application analysis to determine available energy cost reduction and savings.
- 5.0 Requirements of the Manufacturer**
- 5.1 The Manufacturer will insure proper quality control during production, shipping and inventory, clearly identify and label each film core with the product designation and run number.
- 5.2 The Manufacturer will, upon request and pre-approval, provide 100% financing for the complete installation of the window film to the end-user customer in either an installment purchase or lease purchase format to be decided upon by customer.
- 5.3 Materials shall be manufactured by:
3M Consumer Safety and Light Management Department
3M Center, Building 223-02-S-24
St. Paul, MN 55144-1000

6.0 Application

- 6.1 **Examination:** Examine glass surfaces to receive new film and verify that they are free from defects and imperfections which will affect the final appearance. Correct all such deficiencies before starting film application.
- 6.2 **Preparation:**
- a. The window and window framing will be cleaned thoroughly with a neutral cleaning solution. The inside surface of the window glass shall be bladed with industrial razors to insure the removal of any foreign contaminant's.
 - b. Toweling or other absorbent material shall be placed on the window sill or sash to absorb moisture accumulation generated by the film application.
- 6.3 **Installation:** The film shall be applied as to the specifications of the Manufacturer by an ADA.
- a. Materials will be delivered to the job site with the manufacturer's labels intact and legible
 - b. To minimize waste, the film will be cut to specification utilizing a vertical dispenser designed for that purpose. Film edges shall be cut neatly and square at a uniform distance of 1/8" to 1/16" of the window sealing device.
 - c. Clear, clean water will be used to remove the water soluble overcoat that protects the pressure sensitive adhesive. Water and film slip solution only will be used on the window glass to facilitate the proper positioning of the film.
 - d. To insure efficient removal of excess water from the underside of the film and to maximize bonding of the pressure sensitive adhesive, polyplastic bladed squeegees will be utilized.
 - e. Upon completion, the film may have a dimpled appearance from residual moisture. Said moisture shall, under reasonable weather conditions, dry flat with no moisture dimples within a period of 30 calendar days when viewed under normal viewing conditions.
 - f. After installation, any left over material will be removed and the work area will be returned to original condition. Use all necessary means to protect the film before, during and after the installation.

7.0 Cleaning

The film may be washed using common window cleaning solutions, including ammonia solutions, 30 days after application. Abrasive type cleaning agents and bristle brushes which could scratch the film must not be used. Synthetic sponges or soft cloths are recommended.

8.0 Warranty

- 8.1 The application shall be warranted by the film manufacturer (3M) for a period of five (5) years in that the film will maintain solar reflective properties without cracking, crazing, delaminating, bubbling or peeling. In the event that the product is found to be defective under warranty, the seller will replace such quantity of the film proved to be defective, and will additionally provide the removal and reapplication labor free of charge.
- 8.2 The film manufacturer (3M) also warrants against glass failure due to thermal shock fracture of the glass and/or seal failure of the window unit (maximum value \$500 per window) provided the film is applied to recommended types of glass and the failure occurs within sixty (60) months from the start of application. Any glass failure or seal failure must be reviewed by the film manufacturer (3M) prior to replacement.

3M™ Plus All Season Low E Window Film

Title

		LE20SIAR	LE35AMARL
1.0	Scope		
3.1	Thickness		
	(mils)	1.5	1.5
	(inches)	0.0015	0.0015
3.2	Emissivity	0.45	0.34
3.3	U Value	0.82	0.74
3.4	Transmission - Visible	17%	31%
3.5	Reflection - Visible	53%	56%
3.6	Transmission - Ultraviolet	<1%	<1%
3.7	Shading Coefficient	0.25	0.29

Specifications For 3M™ Color-Stable Window Film

1.0 Scope

This specification is for an abrasion resistant solar control window film which when applied to the interior window surface will reduce the gain of solar heat energy through the window. The film shall be called 3M™ Scotchtint™ Color-Stable Window Film_____.

2.0 Applicable Documents

The publications listed below form a part of this specification to the extent referenced. The publications are referred to in the text by the basic designation only.

The 1985 American Society for Heating, Refrigeration, and Air Conditioning Engineers (ASHRAE) Handbook of Fundamentals.

The American Society for Testing and Materials (ASTM) publication:

ASTM E-308 Standard Recommended Practice for Spectrophotometry and Description of Color in CIE 1931 System

ASTM E-903 Standard Methods of Test for Solar Absorbance, Reflectance and Transmittance of Materials Using Integrating Spheres

ASTM D-1044 Standard Method of Test for Resistance of Transparent Plastics to Surface Abrasion (Taber Abrader Test)

ASTM G-90 Standard Practice for Performing Accelerated Outdoor Weatherizing for Non-metallic Materials Using Concentrated Natural Sunlight

ASTM E-84 Standard Method of Test for Surface Burning Characteristics of Building Materials

Window 4.0, A Computer Tool for Analyzing Window Thermal Performance, Lawrence Berkeley Laboratory

3.0 Requirements of the Film

- 3.1 **Film Material:** The film material shall be an optically clear metallized polyester film which may be laminated to a clear polyester film. There must be an acrylic abrasion resistant coating over the surface of the film for enhanced durability. The film color is derived from a metal coating and the product will not contain dyed polyester. The metallic coating shall be uniform without noticeable pin holes, streaks, thin spots, scratches or banding. The variation in total transmission across the width, at any portion along the length, shall not exceed 2% over the average. The film shall have a nominal thickness of _____ mils (_____ inches). The density of the film across the web is not to exceed plus or minus 2%. There shall be no evidence of coating voids. The film shall be identified as to Manufacturer of Origin (hereafter to be called Manufacturer).
- 3.2 **Emissivity:** The emissivity of the non-adhesive surface of the film shall be _____ nominal when measured using a Devices & Services Emissometer Model AE at or near room temperature. The Manufacturer shall provide laboratory data of emissivity and calculated window "U" Values for various outdoor temperatures based upon established calculation procedure defined by the 1985 ASHRAE Handbook of Fundamentals, ch. 27, or Lawrence Berkeley Laboratory Window 4.0 Computer Program.
- 3.3 **U Value:** The U Value of the film applied to 1/4" (6mm) clear glass shall be _____ nominal when measured in accordance with test procedures described in 3.2 for Emissivity.
- 3.4 **Transmission - Visible:** When applied to 1/4" (6mm) clear glass, the luminous transmittance shall be _____ nominal when measured with an integrating sphere spectrophotometer as referenced by ASTM E-903 and calculated per ASTM E-308 using Standard Source "C" for average daylight.
- 3.5 **Reflection - Visible:** When applied to 1/4" (6mm) clear glass, the total luminous reflection from the glass surface shall be _____ nominal when measured with an integrating sphere spectrophotometer as referenced by ASTM E-903 and calculated per ASTM E-308 using Standard CIE Source "C" for average daylight.

- 3.6 **Transmission - Ultraviolet Light:** When applied to 1/4" (6mm) clear glass, the total transmission of solar ultraviolet radiation of air mass = 2 over the spectral range of 3000 to 3800 angstroms shall not exceed _____ when measured with an integrating sphere spectrophotometer as referenced by ASTM E-903.
- 3.7 **Shading Coefficient:** When applied to 1/4" (6mm) clear glass, the shading coefficient shall be _____ nominal when solar energy transmittance and reflection are measured per ASTM E-903 and the shading coefficient is computed in accordance with the established procedures defined by The ASHRAE Handbook of Fundamentals.
- 3.8 **Adhesive System:** The film shall be supplied with a pressure sensitive weatherable acrylate adhesive applied uniformly over the surface opposite the abrasion resistant coating. A water soluble detackifier shall be incorporated over the pressure sensitive adhesive to facilitate handling. The adhesive shall be essentially optically flat and shall meet the following criteria:
- a. Viewing the film from a distance of ten feet (3 m) at angles up to 45 degrees from either side of the glass, the film itself shall not appear distorted.
- 3.9 **Flammability:** The Manufacturer shall provide independent test data showing that the window film shall meet the requirements of a Class A Interior Finish for Building Materials for both Flame Spread Index and Smoke Development Values per ASTM E-84.
- 3.10 **Abrasion Resistance:** The Manufacturer shall provide independent test data showing that the film shall have a surface coating that is resistant to abrasion such that, less than 5% increase of transmitted light haze will result in accordance with ASTM D-1044 using 100 cycles, 500 grams weight, and the CS10F Calbrase Wheel.

4.0 Requirements of the Authorized Dealer/Applicator (ADA)

- 4.1 The ADA shall provide documentation that the ADA is certified by the Manufacturer to install window film as per the Manufacturer's specifications and in accordance with specific requests as to be determined and agreed to by the customer.
- 4.2 Authorization of dealership may be verified through the company's 3M I.D. Number.
- 4.3 The ADA will provide a commercial building reference list of ten (10) properties where the ADA has installed window film. This list will include the following information:
- * Name of building
 - * The name and telephone number of a management contact
 - * Type of glass
 - * Type of film
 - * Amount of film installed
 - * Date of completion
- 4.4 Upon request, the ADA will provide a Glass Stress Analysis of the existing glass and proposed glass/film combination as recommended by the film Manufacturer.
- 4.5 Upon request, the ADA will provide an application analysis to determine available energy cost reduction and savings.

5.0 Requirements of the Manufacturer

- 5.1 The Manufacturer will insure proper quality control during production, shipping and inventory, clearly identify and label each film core with the product designation and run number.
- 5.2 The Manufacturer will, upon request and pre-approval, provide 100% financing for the complete installation of the window film to the end-user customer in either an installment purchase or lease purchase format to be decided upon by customer.
- 5.3 Materials shall be manufactured by:

3M Consumer Safety and Light Management Department
3M Center, Building 223-02-S-24
St. Paul, MN 55144-1000

6.0 Application

6.1 **Examination:** Examine glass surfaces to receive new film and verify that they are free from defects and imperfections which will affect the final appearance. Correct all such deficiencies before starting film application.

6.2 Preparation:

- a. The window and window framing will be cleaned thoroughly with a neutral cleaning solution. The inside surface of the window glass shall be bladed with industrial razors to insure the removal of any foreign contaminant's.
- b. Toweling or other absorbent material shall be placed on the window sill or sash to absorb moisture accumulation generated by the film application.

6.3 **Installation:** The film shall be applied as to the specifications of the Manufacturer by an ADA.

- a. Materials will be delivered to the job site with the manufacturer's labels intact and legible.
- b. To minimize waste, the film will be cut to specification utilizing a vertical dispenser designed for that purpose. Film edges shall be cut neatly and square at a uniform distance of 1/8" (3mm) to 1/16" (1,5mm) of the window sealing device.
- c. Clear, clean water will be used to remove the water soluble overcoat that protects the pressure sensitive adhesive. Water and film slip solution only will be used on the window glass to facilitate the proper positioning of the film.
- d. To insure efficient removal of excess water from the underside of the film and to maximize bonding of the pressure sensitive adhesive, polyplastic bladed squeegees will be utilized.
- e. Upon completion, the film may have a dimpled appearance from residual moisture. Said moisture shall, under reasonable weather conditions, dry flat with no moisture dimples within a period of 30 calendar days when viewed under normal viewing conditions.
- f. After installation, any left over material will be removed and the work area will be returned to original condition. Use all necessary means to protect the film before, during and after the installation.

7.0 Cleaning

The film may be washed using common window cleaning solutions, including ammonia solutions, 30 days after application. Abrasive type cleaning agents and bristle brushes which could scratch the film must not be used. Synthetic sponges or soft cloths are recommended.

8.0 Warranty

- 8.1 The application shall be warranted by the film manufacturer (3M) for a period of ten (10) years in that the film will maintain solar reflective properties without cracking, crazing, delaminating or peeling. Film manufacturer also warrants that SPCS films will not fade or discolor for a period of ten (10) years after installation. In the event that the product is found to be defective under warranty, the seller will replace such quantity of the film proved to be defective, and will additionally provide the removal and reapplication labor free of charge.
- 8.2 The film manufacturer (3M) also warrants against glass failure due to thermal shock fracture of the glass and/or seal failure of the window unit (maximum value \$500 per window) provided the film is applied to recommended types of glass and the failure occurs within sixty (60) months from the start of application. Any glass failure or seal failure must be reviewed by the film manufacturer (3M) prior to replacement.

3M™ Color-Stable and Super Performance Color-Stable Window Film

Color-Stable	CS5	CS20	CS35	CS50
Total solar energy rejected	58%	52%	39%	33%
Glare reduction	92%	82%	57%	42%
Heat reduction	49%	41%	26%	18%
UV reduction	99%	99%	99%	99%
Shading Coefficient	0.48	0.55	0.70	0.77
Visible light transmission	8%	16%	38%	51%
Visible light reflected	5%	5%	6%	7%

Super Performance Color-Stable	SPCS10	SPCS20	SPCS35
Total solar energy rejected	63%	55%	49%
Glare reduction	89%	75%	57%
Heat reduction	54%	45%	37%
UV reduction	99%	99%	99%
Shading Coefficient	0.43	0.52	0.59
Visible light transmission	10%	22%	38%
Visible light reflected (interior)	5%	6%	10%
Visible light reflected (exterior)	10%	9%	9%

Specifications For 3M™ Ultra High Performance Safety and Security Window Film

1.0 Scope

This specification is for a shatter resistant and abrasion resistant window film which when applied to the interior window surface will help hold broken glass together and reduce the ultra-violet light that normally would enter through the window. Sun Control types additionally will provide heat and glare reduction. The film shall be called **3M™ Scotchshield™** Ultra Safety and Security Window Film

2.0 Applicable Documents

The publications listed below form a part of this specification to the extent referenced. The publications are referred to in the text by the basic designation only.

The 1985 American Society for Heating, Refrigeration, and Air Conditioning Engineers (ASHRAE) Handbook of Fundamentals.

The American National Standards Institute (ANSI).

ANSI Z97 Specification for Safety Glazing Material used in Buildings

Sec 5.1 Impact Test: 100-ft/lb. minimum

Sec 5.3 Intensified Weathering

The American Society for Testing and Materials (ASTM) publication:

ASTM E-308 Standard Recommended Practice for Spectrophotometry and Description of Color in CIE 1931 System

ASTM E-903 Standard Methods of Test for Solar Absorbance, Reflectance and Transmittance of Materials Using Integrating Spheres

ASTM D-1044 Standard Method of Test for Resistance of Transparent Plastics to Surface Abrasion (Taber Abrader Test)

ASTM G-90 Standard Practice for Performing Accelerated Outdoor Weathering for Non-metallic Materials Using Concentrated Natural Sunlight

ASTM E-84 Standard Method of Test for Surface Burning Characteristics of Building Materials

ASTM D-1004 Standard Method of Test for Resistance of Transparent Plastics to Tearing (Graves Tear Test)

ASTM F-1642-96 Standard Method of Test for Glazing and Glazing Systems Subject to Airblast Loadings, as adapted by the U.S. Government GSA Test Standard Protocols

The Consumer Products Safety Commission (CPSC)

CFR16, Part 1201 Safety Standards for Architectural Glazing Material

Impact Performance

Accelerated Weathering

Window 4.1. A Computer Tool for Analyzing Window Thermal Performance, Lawrence Berkeley Laboratory

3.0 Requirements of the Film

3.1 Film Material - Clear: The film material shall consist of an optically clear micro-layered polyester film (SCLARL150), laminated to another clear micro-layered polyester film (SCLARL400), and again laminated to a third micro-layered polyester film (ULTRA600), with a durable acrylic abrasion resistant coating over the surface. The film color is clear and will not contain dyed polyester. The film shall have a nominal thickness of _____ mils (_____ inches). There shall be no evidence of coating voids. The film shall be identified as to Manufacturer of Origin (hereafter to be called Manufacturer).

Or

3.1 **Film Material - Sun Control:** The film material shall consist of an optically clear multi-layered polyester film laminated to a metallized multi-layered polyester film (S20SIAR400, S35NEAR400, S50NEAR400), with a durable acrylic abrasion resistant coating over the surface. The film color is derived from the metal coating and the product will not contain dyed polyester. The metallic coating shall be uniform without noticeable pinholes, streaks, thin spots, scratches or banding. The film shall have a nominal thickness of _____ mils (_____ inches). There shall be no evidence of coating voids. The film shall be identified as to Manufacturer of Origin (hereafter to be called Manufacturer).

Or

3.1 **Film Material - Ultra Night Vision:** The film material shall consist of an optically clear multi-layered polyester film laminated to a metallized multi-layered polyester film. Another film layer is add for color and performance (S25NVAR400), with a durable acrylic abrasion resistant coating over the surface. The film color is derived from the metal coating and additional layer and is stable. The metallic coating shall be uniform without noticeable pinholes, streaks, thin spots, scratches or banding. The film shall have a nominal thickness of _____ mils (_____ inches). There shall be no evidence of coating voids. The film shall be identified as to Manufacturer of Origin (hereafter to be called Manufacturer).

3.2 **Emissivity:** The emissivity of the non-adhesive surface of the film shall be _____ nominal when measured using a Devices & Services Emissometer Model AE at or near room temperature. The Manufacturer shall provide laboratory data of emissivity and calculated window "U" Values for various outdoor temperatures based upon established calculation procedure defined by the 1985 ASHRAE Handbook of Fundamentals, Ch. 27., or Lawrence Berkeley Laboratory Window 4.0 Computer Program.

3.3 **U Value:** The U Value of the film applied to 1/4" (6mm) clear glass shall be _____ nominal when measured in accordance with test procedures described in 3.2 for Emissivity.

3.4 **Transmission - Visible:** When applied to 1/4" (6mm) clear glass, the luminous transmittance shall be _____ nominal when measured with an integrating sphere spectrophotometer as referenced by ASTM E-903 and calculated per ASTM E-308 using Standard Source "C" for average daylight.

3.5 **Reflection - Visible:** When applied to 1/4" (6mm) clear glass, the total luminous reflection from the glass surface shall be _____ nominal when measured with an integrating sphere spectrophotometer as referenced by ASTM E-903 and calculated per ASTM E-308 using Standard CIE Source "C" for average daylight.

3.6 **Transmission - Ultraviolet Light:** When applied to 1/4" (6mm) clear glass, the total transmission of solar ultraviolet radiation of air mass = 2 over the spectral range of 3000 to 3800 angstroms shall not exceed _____ when measured with an integrating sphere spectrophotometer as referenced by ASTM E-903.

3.7 **Shading Coefficient:** When applied to 1/4" (6mm) clear glass, the shading coefficient shall be _____ nominal when solar energy transmittance and reflection are measured per ASTM E-903 and the shading coefficient is computed in accordance with the established procedures defined by The ASHRAE Handbook of Fundamentals.

3.8 **Adhesive System:** The film shall be supplied with a high mass pressure sensitive weatherable acrylate adhesive applied uniformly over the surface opposite the abrasion resistant coated surface. A water soluble detackifier shall be incorporated over the pressure sensitive adhesive to facilitate handling. The adhesive shall be essentially optically flat and shall meet the following criteria:

- a. Viewing the film from a distance of ten feet at angles up to 45 degrees from either side of the glass, the film itself shall not appear distorted.
- b. It shall not be necessary to seal around the edges of the applied film system with a lacquer or other substance in order to prevent moisture or free water from penetrating under the film system.

- 3.9 **Flammability:** The Manufacturer shall provide independent test data showing that the window film shall meet the requirements of a Class A Interior Finish for Building Materials for both Flame Spread Index and Smoked Development Values per ASTM E-84.
- 3.10 **Abrasion Resistance:** The Manufacturer shall provide independent test data showing that the film shall have a surface coating that is resistant to abrasion such that, less than 5% increase of transmitted light haze will result in accordance with ASTM D-1044 using 100 cycles, 500 grams weight, and the CS10F Calbrase Wheel.
- 3.11 **Tear Resistance:** The film shall meet a minimum tear resistance value of _____ (lbs. x %) when measured in accordance with ASTM D-1004 (Graves Area Tear Test) at 20 inches/minute (508 mm/minute).
- 3.12 **Safety Glazing:** The film, when applied to either side of the window glass, shall pass a _____ ft/lb. impact when tested according to CPSC CFR16, Part 1201 and shall pass the accelerated weathering test requirements for both tensile strength and peel strength.
- 3.13 **Large Scale Explosive Blast Testing:** The film, when applied to 1/4-inch (6 mm) glass shall meet a minimum performance level of 3 when open-air blast tested to a minimum of 4.0 PSI with 25/msp peak-over pressure and tested according to GSA Test Standard Protocols. This is an adaptation of ASTM F1642-96.
- 3.14 **Tensile Strength:** The film shall have an average tensile strength of 30,000 PSI when tested in accordance with ASTM D882-95a.
- 3.15 **Young's Modulus (PSI):** The film shall have a Young's Modulus of no greater than 500,000 PSI when tested in accordance with ASTM D-882-95a
- 3.16 **PPT (Puncture Propagation Tear):** The film shall have an average PPT value of _____ lbs. when tested in accordance with ASTM D-2582-93.
- 3.17 **Elongation:** The film shall have an average elongation of 140% when tested in accordance with ASTM D-2582-95a.
- 3.18 **Break Strength (1 inch per width):** The film shall have average break strength of 30 lbs. per mil of film thickness.

4.0 Requirements of the Authorized Dealer/Applicator (ADA)

- 4.1 The ADA shall provide documentation that the ADA is certified by the Manufacturer of the window film to install said window film as per the Manufacturer's specifications and in accordance with specific requests as to be determined and agreed to by the customer.
- 4.2 Authorization of dealership may be verified through the company's 3M ID Number.
- 4.3 The ADA will provide a commercial building reference list of ten (10) properties where the ADA has installed window film. This list will include the following information:
 - * Name of building
 - * The name and telephone number of a management contact
 - * Type of glass
 - * Type of film
 - * Amount of film installed
 - * Date of completion
- 4.4 Upon request, the ADA will provide a Glass Stress Analysis of the existing glass and proposed glass/film combination as recommended by the film Manufacturer.
- 4.5 Upon request, the ADA will provide an application analysis to determine available energy cost reduction and savings.

5.0 Requirements of the Manufacturer

- 5.1 The Manufacturer will insure proper quality control during production, shipping and inventory, clearly identify and label each film core with the product designation and run number.
- 5.2 The Manufacturer will, upon request and pre-approval, provide 100% financing for the complete installation of the window film to the end-user customer in either an installment purchase or lease purchase format to be decided upon by customer.

5.3 Materials shall be manufactured by:

3M Consumer Safety and Light Management Department
3M Center, Building 223-02-S-24
St. Paul, MN 55144-1000

6.0 Application

6.1 **Examination:** Examine glass surfaces to receive new film and verify that they are free from defects and imperfections, which will affect the final appearance. Correct all such deficiencies before starting film application.

6.2 Preparation:

- a. The window and window framing will be cleaned thoroughly with a neutral cleaning solution. The inside surface of the window glass shall be bladed with industrial razors to insure the removal of any foreign contaminant's.
- b. Toweling or other absorbent material shall be placed on the window sill or sash to absorb moisture accumulation generated by the film application.

6.3 **Installation:** The film shall be applied as to the specifications of the Manufacturer by an ADA.

- a. Materials will be delivered to the job site with the manufacturer's labels intact and legible.
- b. To minimize waste, the film will be cut to specification utilizing a vertical dispenser designed for that purpose. Film edges shall be cut neatly and square at a uniform distance of 1/8" (3 mm) to 1/16" (1.6 mm) of the window-sealing device.
- c. Clear, clean water will be used to remove the water soluble overcoat that protects the pressure sensitive adhesive. Water and film slip solution only will be used on the window glass to facilitate the proper positioning of the film.
- d. To insure efficient removal of excess water from the underside of the film and to maximize bonding of the pressure sensitive adhesive, polyplastic bladed squeegees will be utilized.
- e. Upon completion, the film shall have a dimpled appearance from residual moisture. Said moisture shall, under reasonable weather conditions, dry flat with no moisture dimples within a period of 30 calendar days when viewed under normal viewing conditions.
- f. After installation, any left over material will be removed and the work area will be returned to original condition. Use all necessary means to protect the film before, during and after the installation.

7.0 Cleaning

The film may be washed using common window cleaning solutions, including ammonia solutions, 30 days after application. Abrasive type cleaning agents and bristle brushes, which could scratch the film, must not be used. Synthetic sponges or soft cloths are recommended.

8.0 Warranty

- 8.1 The application shall be warranted by the film manufacturer (3M) for a period of ten (10) years in that the film will maintain solar reflective properties without cracking, crazing, delaminating, peeling, or discoloration. In the event that the product is found to be defective under warranty, the film manufacturer (3M) will replace such quantity of the film proved to be defective, and will additionally provide the removal and reapplication labor free of charge.
- 8.2 The film manufacturer (3M) also warrants against glass failure due to thermal shock fracture of the glass and/or seal failure of the window unit (maximum value \$500 per window) provided the film is applied to recommended types of glass and the failure occurs within sixty (60) months from the start of application. Any glass failure or seal failure must be reviewed by the film manufacturer (3M) prior to replacement.

3M™ Ultra High Performance Safety and Security Window Film

Title - Clear

		SCLARL150	SCLARL400	ULTRA600
1.0	Scope			
3.1	Thickness (mils) (inches)	2.0 0.0020	4.0 0.0040	6.0 0.0060
3.2	Emissivity	0.87	0.87	0.87
3.3	U Value	1.09	1.09	1.09
3.4	Transmission - Visible	87%	86%	85%
3.5	Reflection - Visible	11%	11%	10%
3.6	Transmission - Ultraviolet	<2%	<2%	<2%
3.7	Shading Coefficient	0.92	0.91	0.90
3.11	Tear Resistance	>350 lbs. %	>780 lbs. %	>1150 lbs. %
3.12	Safety Glazing	150 ft/lbs. Category I	400 ft/lbs. Category II	400 ft/lbs. Category II
3.13	Air-Blast Testing – Minimum Level 3 @ 4.0 PSI	N/A	Yes	Yes
3.14	Tensile Strength	30,000 PSI	30,000 PSI	30,000 PSI
3.15	Young's Modulus	< 500k PSI	500k PSI	500k PSI
3.16	PPT (Puncture Propagation Tear)	2.0 lbs.	7.5 lbs.	19.2 lbs.
3.17	Elongation	140%	140%	140%
3.18	Break Strength (Per inch width)	60 lbs.	120 lbs.	180 lbs.

3M™ Ultra High Performance Safety and Security Window Film

Title – Sun Control

	S20SIAR400	S35NEAR400	S50NEAR400	S25NVAR400
1.0	Scope			
3.1	Thickness			
	4.0	5.0	5.0	5.0
	0.0040	0.0050	0.0050	0.0050
3.2	Emissivity			
	0.79	0.87	0.87	0.72
3.3	U Value			
	1.02	1.09	1.09	.82
3.4	Transmission - Visible			
	19%	37%	51%	24%
3.5	Reflection - Visible			
	58%	20%	15%	28%
3.6	Transmission - Ultraviolet			
	<1%	<1%	<1%	<1%
3.7	Shading Coefficient			
	0.26	0.51	0.66	0.43
3.11	Tear Resistance			
	>780 lbs.%	>780 lbs.%	>780 lbs.%	>780 lbs.%
3.12	Safety Glazing			
	400 ft/lbs. Category II	400 ft/lbs. Category II	400 ft/lbs. Category II	400 ft/lbs. Category II
3.13	Air Blast Testing –			
	Yes	Yes	Yes	Yes
	Minimum Level 3 @ 4.0 PSI			
3.14	Tensile Strength			
	30,000 PSI	30,000 PSI	30,000 PSI	30,000 PSI
3.15	Young's Modulus (PSI)			
	< 500k PSI	< 500k PSI	< 500k PSI	< 500k PSI
3.16	PPT (Puncture Propagation Tear)			
	7.5 lbs.	7.5 lbs.	7.5 lbs.	7.5 lbs.
3.17	Elongation			
	140%	140%	140%	140%
3.18	Break Strength (Per inch width)			
	120 lbs.	120 lbs.	120 lbs.	120 lbs.

Specifications

3M™ Specifications For Safety and Security Window Film SH7CLARL

1.0 Scope

This specification is for a shatter resistant and abrasion resistant window film which when applied to the interior window surface will help hold broken glass together and reduce the Ultra-violet light that normally would enter through the window. The film shall be called 3M™ Scotchshield™ Safety and Security Window Film.

2.0 Applicable Documents

The publications listed below form a part of this specification to the extent referenced. The publications are referred to in the text by the basic designation only.

The 1985 American Society for Heating, Refrigeration, and Air Conditioning Engineers (ASHRAE) Handbook of Fundamentals.

The American National Standards Institute (ANSI).

ANSI Z97 Specification for Safety Glazing Material used in Buildings

Sec 5.1 Impact Test: 100-ft/lb. minimum
Sec 5.3 Intensified Weathering

The American Society for Testing and Materials (ASTM) publication:

ASTM E-308 Standard Recommended Practice for Spectrophotometry and Description of Color in CIE 1931 System

ASTM E-903 Standard Methods of Test for Solar Absorbance, Reflectance and Transmittance of Materials Using Integrating Spheres

ASTM D-1044 Standard Method of Test for Resistance of Transparent Plastics to Surface Abrasion (Taber Abrader Test)

ASTM G-90 Standard Practice for Performing Accelerated Outdoor Weathering for Non-metallic Materials Using Concentrated Natural Sunlight

ASTM E-84 Standard Method of Test for Surface Burning Characteristics of Building Materials

ASTM D-1004 Standard Method of Test for Resistance of Transparent Plastics to Tearing (Graves Tear Test)

ASTM F-1642-96 Standard Method of Test for Glazing and Glazing Systems Subject to Airblast Loadings, as adapted by the U.S. Government GSA Test Standard Protocols

The Consumer Products Safety Commission (CPSC)

CFR16, Part 1201 Safety Standards for Architectural Glazing Material
Impact Performance

Window 4.1. A Computer Tool for Analyzing Window Thermal Performance,
Lawrence Berkeley Laboratory

3.0 Requirements of the Film

3.1 Film Material - Clear: The film material shall consist of an optically clear polyester film, with a durable acrylic abrasion resistant coating over the surface. The color is clear. The film shall have a nominal thickness of 7 mils (0.007 inches). There shall be no evidence of coating voids. The film shall be identified as to Manufacturer of Origin (hereafter to be called Manufacturer).

3.2 Emissivity: The emissivity of the non-adhesive surface of the film shall be measured using a Devices & Services Emissometer Model AE at or near room temperature. The Manufacturer shall provide laboratory data of emissivity and calculated window "U" Values for various outdoor temperatures based upon established calculation procedure defined by the 1985 ASHRAE Handbook of Fundamentals, ch. 27, or Lawrence Berkeley Laboratory Window 4.0 Computer

Program.

- 3.3 **U Value:** The U Value of the film applied to 1/4" (6mm) clear glass shall be measured in accordance with test procedures described in 3.2 for Emissivity.
- 3.4 **Transmission - Visible:** When applied to 1/4" (6mm) clear glass, the luminous transmittance shall be measured with an integrating sphere spectrophotometer as referenced by ASTM E-903 and calculated per ASTM E-308 using Standard Source "C" for average daylight.
- 3.5 **Reflection - Visible:** When applied to 1/4" (6mm) clear glass, the total luminous reflection from the glass surface shall be measured with an integrating sphere spectrophotometer as referenced by ASTM E-903 and calculated per ASTM E-308 using Standard CIE Source "C" for average daylight.
- 3.6 **Transmission - Ultraviolet Light:** When applied to 1/4" (6mm) clear glass, the total transmission of solar ultraviolet radiation of air mass = 2 over the spectral range of 3000 to 3800 angstroms shall not exceed measured with an integrating sphere spectrophotometer as referenced by ASTM E-903.
- 3.7 **Shading Coefficient:** When applied to 1/4" (6mm) clear glass, the shading coefficient shall be measured per ASTM E-903 and the shading coefficient is computed in accordance with the established procedures defined by The ASHRAE Handbook of Fundamentals.
- 3.8 **Adhesive System:** The film shall be supplied with a high mass pressure sensitive weatherable acrylate adhesive applied uniformly over the surface opposite the abrasion resistant coated surface. The adhesive shall be essentially optically flat and shall meet the following criteria:
- Viewing the film from a distance of ten feet at angles up to 45 degrees from either side of the glass, the film itself shall not appear distorted.
 - It shall not be necessary to seal around the edges of the applied film system with a lacquer or other substance in order to prevent moisture or free water from penetrating under the film system.
- 3.9 **Flammability:** The Manufacturer shall provide independent test data showing that the window film shall meet the requirements of a Class A Interior Finish for Building Materials for both Flame Spread Index and Smoke Development Values per ASTM E-84.
- 3.10 **Abrasion Resistance:** The Manufacturer shall provide independent test data showing that the film shall have a surface coating that is resistant to abrasion such that, less than 5% increase of transmitted light haze will result in accordance with ASTM D-1044 using 100 cycles, 500 grams weight, and the CS10F Calbrase Wheel.
- 3.11 **Tear Resistance:** The film shall meet a minimum tear resistance value of when measured in accordance with ASTM D-1004 (Graves Area Tear Test) at 20 inches/minute (508 mm/minute).
- 3.12 **Safety Glazing:** The film, when applied to either side of the window glass, shall pass a 400 ft/lb. impact when tested according to CPSC CFR16, Part 1201 and shall pass the accelerated weathering test requirements for both tensile strength and peel strength.
- 3.13 **Large Scale Explosive Blast Testing:** The film, when applied to 1/4-inch (6mm) glass shall meet a minimum performance level of 3 when open-air blast tested to a minimum of 4.0 PSI with 25/msp peak-over pressure and tested according to GSA Test Standard Protocols. This is an adaptation of ASTM F1642-96.
- 3.14 **Tensile Strength:** The film shall have an average tensile strength of 25,000 PSI when tested in accordance with ASTM D882-95a.
- 3.15 **Elongation:** The film shall have an average elongation of 130% when tested in accordance with ASTM D882-95a.
- 3.16 **Break Strength** (1 inch per width): The film shall have an average break strength of 25 lbs. per mil of film thickness.
- 4.0 Requirements of the Authorized Dealer/Applicator (ADA)**
- 4.1 The ADA shall provide documentation that the ADA is certified by the Manufacturer of the window film to install said window film as per the Manufacturer's specifications and in accordance with specific requests as to be determined and agreed to by the customer.

- 4.2 Authorization of dealership may be verified through the company's 3M I.D. Number.
- 4.3 The ADA will provide a commercial building reference list of ten (10) properties where the ADA has installed window film. This list will include the following information:
- * Name of building
 - * The name and telephone number of a management contact
 - * Type of glass
 - * Type of film
 - * Amount of film installed
 - * Date of completion
- 4.4 Upon request, the ADA will provide a Glass Stress Analysis of the existing glass and proposed glass/film combination as recommended by the film Manufacturer.

5.0 Requirements of the Manufacturer

- 5.1 The Manufacturer will insure proper quality control during production, shipping and inventory, clearly identify and label each film core with the product designation and run number.
- 5.2 The Manufacturer will, upon request and pre-approval, provide 100% financing for the complete installation of the window film to the end-user customer in either an installment purchase or lease purchase format to be decided upon by customer.
- 5.3 Materials shall be manufactured by:

3M Consumer Safety and Light Management Department
3M Center, Building 223-02-S-24
St. Paul, MN 55144-1000

6.0 Application

- 6.1 **Examination:** Examine glass surfaces to receive new film and verify that they are free from defects and imperfections which will affect the final appearance. Correct all such deficiencies before starting film application.
- 6.2 **Preparation:**
- a. The window and window framing will be cleaned thoroughly with a neutral cleaning solution. The inside surface of the window glass shall be bladed with industrial razors to insure the removal of any foreign contaminant's.
 - b. Toweling or other absorbent material shall be placed on the window sill or sash to absorb moisture accumulation generated by the film application.
- 6.3 **Installation:** The film shall be applied as to the specifications of the Manufacturer by an ADA.
- a. Materials will be delivered to the job site with the manufacturer's labels intact and legible.
 - b. To minimize waste, the film will be cut to specification utilizing a vertical dispenser designed for that purpose. Film edges shall be cut neatly and square at a uniform distance of 1/8" (3mm) to 1/16" (1.6mm) of the window-sealing device.
 - c. Clear, clean water will be used to remove the water soluble overcoat that protects the pressure sensitive adhesive. Water and film slip solution only will be used on the window glass to facilitate the proper positioning of the film.
 - d. To insure efficient removal of excess water from the underside of the film and to maximize bonding of the pressure sensitive adhesive, polyplastic bladed squeegees will be utilized.
 - e. Upon completion, the film may have a dimpled appearance from residual moisture. Said moisture shall, under reasonable weather conditions, dry flat with no moisture dimples within a period of 30 calendar days when viewed under normal viewing conditions.
 - f. After installation, any left over material will be removed and the work area will be returned to original condition. Use all necessary means to protect the film before, during and after the installation.

7.0 Cleaning

The film may be washed using common window cleaning solutions, including ammonia solutions, 30 days after application. Abrasive type cleaning agents and bristle brushes, which could scratch the film, must not be used. Synthetic sponges or soft cloths are recommended.

8.0 Warranty

8.1 In that the film will maintain solar reflective properties without cracking, crazing, delaminating peeling or discoloration. In the event that the product is found to be defective under warranty, the film manufacturer (3M) will replace such quantity of the film proved to be defective. The application shall be warranted by the film manufacturer (3M) for a period of ten (10) years additionally provide the removal and reapplication labor free of charge.

3M™ Safety and Security Window Film

SH7CLARL

- 1 Thickness
 - Base film (mils) 7.0 (inches) 0.007
 - Applied product 7.8
- 2 Emissivity 0.89
- 3 U Value 1.04
- 4 Transmission
 - Visible 85%
 - Solar 75%
- 5 Reflection
 - Visible 10%
 - Solar 12%
- 6 Transmission - Ultraviolet <2%
- 7 Shading Coefficient 0.91
- 8 Tear Resistance N/A
- 9 Safety Glazing
 - ANSI Z97.1 400 ft/lbs.
 - CPSC Category II 400 ft/lbs
- 10 Tensile Strength 25,000 PSI
- 11 Elongation 130%
- 12 Break Strength (Per inch width) 175 lbs.
- 13 Surface burn: Class A interior use
- 14 Large Scale Explosive open air blast test per GSA Security Criteria **at 4 psi blast load**
 - Daylite level 3
 - 4 side mechanical level 3
 - 4 side Ultraflex level 3

Specifications For 3M™ Safety and Security Window Film SH8CLARL

1.0 Scope

This specification is for a shatter resistant and abrasion resistant window film which when applied to the interior window surface will help hold broken glass together and reduce the Ultra-violet light that normally would enter through the window. The film shall be called 3M™ Scotchshield™ Safety and Security Window Film.

2.0 Applicable Documents

The publications listed below form a part of this specification to the extent referenced. The publications are referred to in the text by the basic designation only.

The 1985 American Society for Heating, Refrigeration, and Air Conditioning Engineers (ASHRAE) Handbook of Fundamentals.

The American National Standards Institute (ANSI).

ANSI Z97 Specification for Safety Glazing Material used in Buildings

Sec 5.1 Impact Test: 100-ft/lb. minimum
Sec 5.3 Intensified Weathering

The American Society for Testing and Materials (ASTM) publication:

ASTM E-308 Standard Recommended Practice for Spectrophotometry and Description of Color in CIE 1931 System

ASTM E-903 Standard Methods of Test for Solar Absorbance, Reflectance and Transmittance of Materials Using Integrating Spheres

ASTM D-1044 Standard Method of Test for Resistance of Transparent Plastics to Surface Abrasion (Taber Abrader Test)

ASTM G-90 Standard Practice for Performing Accelerated Outdoor Weatherizing for Non-metallic Materials Using Concentrated Natural Sunlight

ASTM E-84 Standard Method of Test for Surface Burning Characteristics of Building Materials

ASTM D-1004 Standard Method of Test for Resistance of Transparent Plastics to Tearing (Graves Tear Test)

ASTM F-1642-96 Standard Method of Test for Glazing and Glazing Systems Subject to Airblast Loadings, as adapted by the U.S. Government GSA Test Standard Protocols

The Consumer Products Safety Commission (CPSC)

CFR16, Part 1201 Safety Standards for Architectural Glazing Material
Impact Performance

Window 4.1. A Computer Tool for Analyzing Window Thermal Performance,
Lawrence Berkeley Laboratory

3.0 Requirements of the Film

3.1 Film Material - Clear: The film material shall consist of an optically clear polyester film, with a durable acrylic abrasion resistant coating over the surface. The color is clear. The film shall have a nominal thickness of 8 mils (0.008 inches). There shall be no evidence of coating voids. The film shall be identified as to Manufacturer of Origin (hereafter to be called Manufacturer).

3.2 Emissivity: The emissivity of the non-adhesive surface of the film shall be measured using a Devices & Services Emissometer Model AE at or near room temperature. The Manufacturer shall provide laboratory data of emissivity and calculated window "U" Values for various outdoor temperatures based upon established calculation procedure defined by the 1985 ASHRAE Handbook of Fundamentals, ch. 27, or Lawrence Berkeley Laboratory Window 4.0 Computer

Program.

- 3.3 **U Value:** The U Value of the film applied to 1/4" (6mm) clear glass shall be measured in accordance with test procedures described in 3.2 for Emissivity.
- 3.4 **Transmission - Visible:** When applied to 1/4" (6mm) clear glass, the luminous transmittance shall be measured with an integrating sphere spectrophotometer as referenced by ASTM E-903 and calculated per ASTM E-308 using Standard Source "C" for average daylight.
- 3.5 **Reflection - Visible:** When applied to 1/4" (6mm) clear glass, the total luminous reflection from the glass surface shall be measured with an integrating sphere spectrophotometer as referenced by ASTM E-903 and calculated per ASTM E-308 using Standard CIE Source "C" for average daylight.
- 3.6 **Transmission - Ultraviolet Light:** When applied to 1/4" (6mm) clear glass, the total transmission of solar ultraviolet radiation of air mass = 2 over the spectral range of 3000 to 3800 angstroms shall not exceed measured with an integrating sphere spectrophotometer as referenced by ASTM E-903.
- 3.7 **Shading Coefficient:** When applied to 1/4" (6mm) clear glass, the shading coefficient shall be measured per ASTM E-903 and the shading coefficient is computed in accordance with the established procedures defined by The ASHRAE Handbook of Fundamentals.
- 3.8 **Adhesive System:** The film shall be supplied with a high mass pressure sensitive weatherable acrylate adhesive applied uniformly over the surface opposite the abrasion resistant coated surface. The adhesive shall be essentially optically flat and shall meet the following criteria:
- Viewing the film from a distance of ten feet at angles up to 45 degrees from either side of the glass, the film itself shall not appear distorted.
 - It shall not be necessary to seal around the edges of the applied film system with a lacquer or other substance in order to prevent moisture or free water from penetrating under the film system.
- 3.9 **Flammability:** The Manufacturer shall provide independent test data showing that the window film shall meet the requirements of a Class A Interior Finish for Building Materials for both Flame Spread Index and Smoke Development Values per ASTM E-84.
- 3.10 **Abrasion Resistance:** The Manufacturer shall provide independent test data showing that the film shall have a surface coating that is resistant to abrasion such that, less than 5% increase of transmitted light haze will result in accordance with ASTM D-1044 using 100 cycles, 500 grams weight, and the CS10F Calbrase Wheel.
- 3.11 **Tear Resistance:** The film shall meet a minimum tear resistance value of when measured in accordance with ASTM D-1004 (Graves Area Tear Test) at 20 inches/minute (508 mm/minute).
- 3.12 **Safety Glazing:** The film, when applied to either side of the window glass, shall pass a 400 ft/lb. impact when tested according to CPSC CFR16, Part 1201 and shall pass the accelerated weathering test requirements for both tensile strength and peel strength.
- 3.13 **Large Scale Explosive Blast Testing:** The film, when applied to 1/4-inch (6mm) glass shall meet a minimum performance level of 3 when open-air blast tested to a minimum of 4.0 PSI with 25/msp peak-over pressure and tested according to GSA Test Standard Protocols. This is an adaptation of ASTM F1642-96.
- 3.14 **Tensile Strength:** The film shall have an average tensile strength of 25,000 PSI when tested in accordance with ASTM D882-95a.
- 3.15 **Elongation:** The film shall have an average elongation of 130% when tested in accordance with ASTM D882-95a.
- 3.16 **Break Strength** (1 inch per width): The film shall have an average break strength of 25 lbs. per mil of film thickness.
- 4.0 **Requirements of the Authorized Dealer/Applicator (ADA)**
- 4.1 The ADA shall provide documentation that the ADA is certified by the Manufacturer of the window film to install said window film as per the Manufacturer's specifications and in accordance with specific requests as to be determined and agreed to by the customer.

- 4.2 Authorization of dealership may be verified through the company's 3M I.D. Number.
- 4.3 The ADA will provide a commercial building reference list of ten (10) properties where the ADA has installed window film. This list will include the following information:
- * Name of building
 - * The name and telephone number of a management contact
 - * Type of glass
 - * Type of film
 - * Amount of film installed
 - * Date of completion
- 4.4 Upon request, the ADA will provide a Glass Stress Analysis of the existing glass and proposed glass/film combination as recommended by the film Manufacturer.

5.0 Requirements of the Manufacturer

- 5.1 The Manufacturer will insure proper quality control during production, shipping and inventory, clearly identify and label each film core with the product designation and run number.
- 5.2 The Manufacturer will, upon request and pre-approval, provide 100% financing for the complete installation of the window film to the end-user customer in either an installment purchase or lease purchase format to be decided upon by customer.
- 5.3 Materials shall be manufactured by:

3M Consumer Safety and Light Management Department
3M Center, Building 223-02-S-24
St. Paul, MN 55144-1000

6.0 Application

- 6.1 **Examination:** Examine glass surfaces to receive new film and verify that they are free from defects and imperfections which will affect the final appearance. Correct all such deficiencies before starting film application.
- 6.2 **Preparation:**
- a. The window and window framing will be cleaned thoroughly with a neutral cleaning solution. The inside surface of the window glass shall be bladed with industrial razors to insure the removal of any foreign contaminant's.
 - b. Toweling or other absorbent material shall be placed on the window sill or sash to absorb moisture accumulation generated by the film application.
- 6.3 **Installation:** The film shall be applied as to the specifications of the Manufacturer by an ADA.
- a. Materials will be delivered to the job site with the manufacturer's labels intact and legible.
 - b. To minimize waste, the film will be cut to specification utilizing a vertical dispenser designed for that purpose. Film edges shall be cut neatly and square at a uniform distance of 1/8" (3mm) to 1/16" (1.6mm) of the window-sealing device.
 - c. Clear, clean water will be used to remove the water soluble overcoat that protects the pressure sensitive adhesive. Water and film slip solution only will be used on the window glass to facilitate the proper positioning of the film.
 - d. To insure efficient removal of excess water from the underside of the film and to maximize bonding of the pressure sensitive adhesive, polyplastic bladed squeegees will be utilized.
 - e. Upon completion, the film may have a dimpled appearance from residual moisture. Said moisture shall, under reasonable weather conditions, dry flat with no moisture dimples within a period of 30 calendar days when viewed under normal viewing conditions.
 - f. After installation, any left over material will be removed and the work area will be returned to original condition. Use all necessary means to protect the film before, during and after the installation.

7.0 Cleaning

The film may be washed using common window cleaning solutions, including ammonia solutions, 30 days after application. Abrasive type cleaning agents and bristle brushes, which could scratch the film, must not be used. Synthetic sponges or soft cloths are recommended.

8.0 Warranty

8.1 In that the film will maintain solar reflective properties without cracking, crazing, delaminating, peeling or discoloration. In the event that the product is found to be defective under warranty, the film manufacturer (3M) will replace such quantity of the film proved to be defective. The application shall be warranted by the film manufacturer (3M) for a period of ten (10) years additionally provide the removal and reapplication labor free of charge.

3M™ Safety and Security Window Film

SH8CLARL

- 1 Thickness
 - Base film (mils) 8.0 (inches) 0.008
 - Applied product 8.9
- 2 Emissivity 0.89
- 3 U Value 1.04
- 4 Transmission
 - Visible 84%
 - Solar 74%
- 5 Reflection
 - Visible 10%
 - Solar 12%
- 6 Transmission - Ultraviolet <2%
- 7 Shading Coefficient 0.91
- 8 Tear Resistance N/A
- 9 Safety Glazing
 - ANSI Z97.1 400 ft/lbs.
 - CPSC Category II 400 ft/lbs
- 10 Tensile Strength 25,000 PSI
- 11 Elongation 130%
- 12 Break Strength (Per inch width) 200 lbs.
- 13 Surface burn: Class A interior use

Specifications For 3M™ Safety and Security Window Film SH14CLARL

1.0 Scope

This specification is for a shatter resistant and abrasion resistant window film which when applied to the interior window surface will help hold broken glass together and reduce the Ultra-violet light that normally would enter through the window. The film shall be called 3M™ Scotchshield™ Safety and Security Window Film.

2.0 Applicable Documents

The publications listed below form a part of this specification to the extent referenced. The publications are referred to in the text by the basic designation only.

The 1985 American Society for Heating, Refrigeration, and Air Conditioning Engineers (ASHRAE) Handbook of Fundamentals.

The American National Standards Institute (ANSI).

ANSI Z97 Specification for Safety Glazing Material used in Buildings

Sec 5.1 Impact Test: 100-ft/lb. minimum
Sec 5.3 Intensified Weathering

The American Society for Testing and Materials (ASTM) publication:

ASTM E-308 Standard Recommended Practice for Spectrophotometry and Description of Color in CIE 1931 System

ASTM E-903 Standard Methods of Test for Solar Absorbance, Reflectance and Transmittance of Materials Using Integrating Spheres

ASTM D-1044 Standard Method of Test for Resistance of Transparent Plastics to Surface Abrasion (Taber Abrader Test)

ASTM G-90 Standard Practice for Performing Accelerated Outdoor Weathering for Non-metallic Materials Using Concentrated Natural Sunlight

ASTM E-84 Standard Method of Test for Surface Burning Characteristics of Building Materials

ASTM D-1004 Standard Method of Test for Resistance of Transparent Plastics to Tearing (Graves Tear Test)

ASTM F-1642-96 Standard Method of Test for Glazing and Glazing Systems Subject to Airblast Loadings, as adapted by the U.S. Government GSA Test Standard Protocols

The Consumer Products Safety Commission (CPSC)

CFR16, Part 1201 Safety Standards for Architectural Glazing Material
Impact Performance

Window 4.1. A Computer Tool for Analyzing Window Thermal Performance,
Lawrence Berkeley Laboratory

3.0 Requirements of the Film

3.1 Film Material - Clear: The film material shall consist of an optically clear polyester film, with a durable acrylic abrasion resistant coating over the surface. The color is clear. The film shall have a nominal thickness of 14 mils (0.014 inches). There shall be no evidence of coating voids. The film shall be identified as to Manufacturer of Origin (hereafter to be called Manufacturer).

3.2 Emissivity: The emissivity of the non-adhesive surface of the film shall be measured using a Devices & Services Emissometer Model AE at or near room temperature. The Manufacturer shall provide laboratory data of emissivity and calculated window "U" Values for various outdoor temperatures based upon established calculation procedure defined by the 1985 ASHRAE Handbook of Fundamentals, ch. 27, or Lawrence Berkeley Laboratory Window 4.0 Computer Program.

- 3.3 **U Value:** The U Value of the film applied to 1/4" (6mm) clear glass shall be measured in accordance with test procedures described in 3.2 for Emissivity.
- 3.4 **Transmission - Visible:** When applied to 1/4" (6mm) clear glass, the luminous transmittance shall be measured with an integrating sphere spectrophotometer as referenced by ASTM E-903 and calculated per ASTM E-308 using Standard Source "C" for average daylight.
- 3.5 **Reflection - Visible:** When applied to 1/4" (6mm) clear glass, the total luminous reflection from the glass surface shall be measured with an integrating sphere spectrophotometer as referenced by ASTM E-903 and calculated per ASTM E-308 using Standard CIE Source "C" for average daylight.
- 3.6 **Transmission - Ultraviolet Light:** When applied to 1/4" (6mm) clear glass, the total transmission of solar ultraviolet radiation of air mass = 2 over the spectral range of 3000 to 3800 angstroms shall not exceed measured with an integrating sphere spectrophotometer as referenced by ASTM E-903.
- 3.7 **Shading Coefficient:** When applied to 1/4" (6mm) clear glass, the shading coefficient shall be measured per ASTM E-903 and the shading coefficient is computed in accordance with the established procedures defined by The ASHRAE Handbook of Fundamentals.
- 3.8 **Adhesive System:** The film shall be supplied with a high mass pressure sensitive weatherable acrylate adhesive applied uniformly over the surface opposite the abrasion resistant coated surface. The adhesive shall be essentially optically flat and shall meet the following criteria:
- a. Viewing the film from a distance of ten feet at angles up to 45 degrees from either side of the glass, the film itself shall not appear distorted.
 - b. It shall not be necessary to seal around the edges of the applied film system with a lacquer or other substance in order to prevent moisture or free water from penetrating under the film system.
- 3.9 **Flammability:** The Manufacturer shall provide independent test data showing that the window film shall meet the requirements of a Class A Interior Finish for Building Materials for both Flame Spread Index and Smoke Development Values per ASTM E-84.
- 3.10 **Abrasion Resistance:** The Manufacturer shall provide independent test data showing that the film shall have a surface coating that is resistant to abrasion such that, less than 5% increase of transmitted light haze will result in accordance with ASTM D-1044 using 100 cycles, 500 grams weight, and the CS10F Calbrase Wheel.
- 3.11 **Tear Resistance:** The film shall meet a minimum tear resistance value of when measured in accordance with ASTM D-1004 (Graves Area Tear Test) at 20 inches/minute (508 mm/minute).
- 3.12 **Safety Glazing:** The film, when applied to either side of the window glass, shall pass a 400 ft/lb. impact when tested according to CPSC CFR16, Part 1201 and shall pass the accelerated weathering test requirements for both tensile strength and peel strength.
- 3.13 **Large Scale Explosive Blast Testing:** The film, when applied to 1/4-inch (6mm) glass shall meet a minimum performance level of 3 when open-air blast tested to a minimum of 4.0 PSI with 25/msp peak-over pressure and tested according to GSA Test Standard Protocols. This is an adaptation of ASTM F1642-96.
- 3.14 **Tensile Strength:** The film shall have an average tensile strength of 25,000 PSI when tested in accordance with ASTM D882-95a.
- 3.15 **Elongation:** The film shall have an average elongation of 130% when tested in accordance with ASTM D882-95a.
- 3.16 **Break Strength** (1 inch per width): The film shall have an average break strength of 25 lbs. per mil of film thickness.
- 4.0 **Requirements of the Authorized Dealer/Applicator (ADA)**
- 4.1 The ADA shall provide documentation that the ADA is certified by the Manufacturer of the window film to install said window film as per the Manufacturer's specifications and in accordance with specific requests as to be determined and agreed to by the customer.
- 4.2 Authorization of dealership may be verified through the company's 3M I.D. Number.

4.3 The ADA will provide a commercial building reference list of ten (10) properties where the ADA has installed window film. This list will include the following information:

- * Name of building
- * The name and telephone number of a management contact
- * Type of glass
- * Type of film
- * Amount of film installed
- * Date of completion

4.4 Upon request, the ADA will provide a Glass Stress Analysis of the existing glass and proposed glass/film combination as recommended by the film Manufacturer.

5.0 Requirements of the Manufacturer

5.1 The Manufacturer will insure proper quality control during production, shipping and inventory, clearly identify and label each film core with the product designation and run number.

5.2 The Manufacturer will, upon request and pre-approval, provide 100% financing for the complete installation of the window film to the end-user customer in either an installment purchase or lease purchase format to be decided upon by customer.

5.3 Materials shall be manufactured by:

3M Consumer Safety and Light Management Department
3M Center, Building 223-02-S-24
St. Paul, MN 55144-1000

6.0 Application

6.1 **Examination:** Examine glass surfaces to receive new film and verify that they are free from defects and imperfections which will affect the final appearance. Correct all such deficiencies before starting film application.

6.2 **Preparation:**

- a. The window and window framing will be cleaned thoroughly with a neutral cleaning solution. The inside surface of the window glass shall be bladed with industrial razors to insure the removal of any foreign contaminant's.
- b. Toweling or other absorbent material shall be placed on the window sill or sash to absorb moisture accumulation generated by the film application.

6.3 **Installation:** The film shall be applied as to the specifications of the Manufacturer by an ADA.

- a. Materials will be delivered to the job site with the manufacturer's labels intact and legible.
- b. To minimize waste, the film will be cut to specification utilizing a vertical dispenser designed for that purpose. Film edges shall be cut neatly and square at a uniform distance of 1/8" (3mm) to 1/16" (1.6mm) of the window-sealing device.
- c. Clear, clean water will be used to remove the water soluble overcoat that protects the pressure sensitive adhesive. Water and film slip solution only will be used on the window glass to facilitate the proper positioning of the film.
- d. To insure efficient removal of excess water from the underside of the film and to maximize bonding of the pressure sensitive adhesive, polyplastic bladed squeegees will be utilized.
- e. Upon completion, the film may have a dimpled appearance from residual moisture. Said moisture shall, under reasonable weather conditions, dry flat with no moisture dimples within a period of 30 calendar days when viewed under normal viewing conditions.
- f. After installation, any left over material will be removed and the work area will be returned to original condition. Use all necessary means to protect the film before, during and after the installation.

7.0 Cleaning

The film may be washed using common window cleaning solutions, including ammonia solutions, 30 days after application. Abrasive type cleaning agents and bristle brushes, which could scratch the film, must not be used. Synthetic sponges or soft cloths are recommended.

8.0 Warranty

8.1 In that the film will maintain solar reflective properties without cracking, crazing, delaminating peeling or discoloration. In the event that the product is found to be defective under warranty, the film manufacturer (3M) will replace such quantity of the film proved to be defective. The application shall be warranted by the film manufacturer (3M) for a period of ten (10) years additionally provide the removal and reapplication labor free of charge.

3M™ Safety and Security Window Film

SH14CLARL

- 1 Thickness
 - Base film (mils) 14.0 (inches) 0.014
 - Applied product 14.8
- 2 Emissivity 0.89
- 3 U Value 1.04
- 4 Transmission
 - Visible 82%
 - Solar 74%
- 5 Reflection
 - Visible 10%
 - Solar 12%
- 6 Transmission - Ultraviolet <2%
- 7 Shading Coefficient 0.89
- 8 Tear Resistance N/A
- 9 Safety Glazing
 - ANSI Z97.1 400 ft/lbs.
 - CPSC Category II 400 ft/lbs
- 10 Tensile Strength 25,000 PSI
- 11 Elongation 130%
- 12 Break Strength (Per inch width) 350 lbs.
- 13 Surface burn: Class A interior use
- 14 Large Scale Explosive open air blast test per GSA Security Criteria **at 4 psi blast load**
 - Day-lite level 3
 - 4 side mechanical level 3
 - 4 side Ultraflex level 3

GLOSSARY of ARCHITECTURAL WINDOW TERMS

AAMA

American Architectural Manufacturers Association. A national trade association that establishes voluntary standards for the aluminum window, door, and skylight industry.

ABSORPTANCE

The fraction of incident radiation that is absorbed.

ACRYLIC (Plastic, Plexiglas)

A non crystalline thermoplastic with good weather resistance, shatter resistance, and optical clarity; sometimes used for glazing.

ADHESION

The ability of a coating or sealant to stick or bond to the surface to which it is applied.

ADHESIVE FAILURE

Failure of a compound by pulling away from the surface with which it is in contact. (See cohesive failure.)

ALLOY

A metal to which another element has been added, generally another metal.

ANNEALED GLASS

Standard sheet or plate glass.

ANNEALING

To heat above the critical or recrystallization temperature, then controlled cooling of glass or other materials to eliminate the effects of cold-working, relieve internal stresses or improve strength, ductility, or other properties.

ANSI

American National Standards Institute. Clearing house for all types of standards and specifications.

ASHRAE

Abbreviation for the American Society of Heating, Refrigerating and Air-conditioning Engineers.

ASTM

American Society for Testing and Materials. A society of engineers which sets standards for testing of materials.

BOCA

Building Officials and Code Administrators.

BRONZE

An alloy of copper and tin.

BTU (British Thermal Unit)

The energy used for heating and cooling is measured by the number of BTUs needed to keep a building at a comfortable temperature. Scientifically, it is the amount of heat energy necessary to raise the temperature of one pound of water one degree Fahrenheit (1 Btu = 252 calories).

CABO

Council of American Building Officials.

CCF

An abbreviation for one hundred cubic feet. A unit of natural gas consumption. Equivalent to 100,000 Btu's (105.5 MJ) of energy or heat.

CLOUDINESS INDEX

The percent of extraterrestrial radiation that reaches the earth surface when measured on a horizontal plane.

COHESIVE FAILURE

Splitting and opening of a compound resulting from over-extension of the compound. (See adhesive failure)

COMPATIBILITY

The ability of two or more materials to exist in close and permanent association for an indefinite period with no adverse effect of one on the other.

CONDENSATION

When water vapor, which is present in all but the driest air, comes on contact with a surface that is below what is called the "dew point temperature," the vapor becomes liquid and is called condensation. An example is as follows: Condensation forms on a glass of ice water since the surface of the glass is down to the dew point temperature of the inside air.

CONDUCTION

Process to heat transfer through a material from a warm surface to a cool surface.

CONDUCTION FACTOR

The difference in the "U-values" before and after film application to glass multiplied by 24 hours/day. This factor is used in calculating heating energy savings.

CONVECTION

Heat transfer by the movement of fluid or air.

COOLING DAYS

The number of days in a year that the air conditioning equipment is used.

COOLING DEGREE-DAY

Cooling and heating engineers have found a way to relate the typical climate conditions of different areas to the amount of energy needed to cool and heat a building. The term they use is “Degree-Day” using a base temperature of 65°F (18°C). A cooling degree-day is counted for each degree above 65°F (18°C) reached by the average (between the highest and lowest) daily outside temperatures in the summer. For example, if on a given summer day the high is 90°F (32°C) and the low is 70°F (21°C), the daily average temperature is 80°F (26°C). This is 15°F (8°C) above the base temperature of 65°F (18°C difference). So, on that day, you would have gone through 15 (8) cooling degree-days.

CORROSION

The deterioration of metal by chemical or electro-chemical reaction resulting from exposure to weathering, moisture, chemicals, or other agents or media.

CRF (Condensation Resistance Factor)

Gives an indication of a window’s ability to resist condensation. The higher the CRF, the less likely condensation is to occur.

CURTAIN WALL

An exterior building wall which carries no roof or floor loads and consists entirely or principally of metal, or a combination of metal, glass, and other surfacing materials supported by a metal framework. There are two basic types:

CUSTOM: Walls designed specifically for one project, and using parts and details specially made for this purpose.

STANDARDS: Walls made up principally of parts and details standardized by their manufacturer and assembled in accord with either the architect’s design or the manufacturer’s stock patterns.

DEGREE-DAY

A unit that represents a 1°F (1°C) deviation from some fixed reference point (usually 65°F [18°C]) in the mean, daily outdoor temperature. (See heating degree-day and cooling degree day)

DESICCANT

An extremely porous crystalline substance used to absorb moisture from within the sealed air space of an insulating glass unit.

DEW POINT

The temperature at which the condensation of water vapor in a space. Used in testing sealed insulated glass. The lower the number, the higher the resistance to forming condensation.

DOUBLE GLAZING

In general, any use of two panes of glass, separated by an air space, within an opening, to improve insulation against heat transfer and/or sound transmission. In factory-made double glazing units the air between the glass sheets is thoroughly dried and the space is sealed airtight, eliminating possible condensation and providing superior insulating properties. (See sealed insulating glass.)

EDGE CLEARANCE

The distance between the edge of a unit of glass or panel and its surrounding frame, measured normal to the edge in the plane of the glass or panel.

ELASTICITY

Pliability, ability to take up expansion and contraction; opposite of brittleness.

EMI

An abbreviation for Electromagnetic Interference.

EMISSIVITY

This is a measure of the ability of a surface to emit room temperature radiant heat energy. It is also a measure of the ability of the surface to reflect room radiant energy since, for window systems, the emissivity and the reflectivity of room radiant energy add up to unity. A low emissivity means a high reflectivity of room radiant energy.

EXTERIOR GLAZED

Glass set from the exterior of the building.

FENESTRATION

An opening in a building.

FLOAT GLASS

Glass which has its bottom surfaces formed by floating on molten metal, the top surface being gravity formed, producing a high optical quality of glass with parallel surfaces and, without polishing and grinding, the fire-finished brilliance of the finest sheet glass. Float glass is replacing plate glass.

FOGGING

A deposit of contamination left on the inside surface of the sealed insulating glass unit due to extremes of temperatures. Usually happens with failed sealed insulated glass.

GLARE REDUCTION

This is the ratio of the difference in visible transmission of the glass before and after installing film to the visible transmission of the glass with no film. It is expressed as a percentage and is determined by the respective visible transmission values of the glass with and without film.

GLASS

A transparent, brittle substance formed by fusing sand with soda or potash or both; it often has lime, alumina or lead oxide.

GLASS EDGE STRESS

An amount of force in pounds per square inch (psi) (kg/cm²) experienced by the edge of the glass pane.

GLASS THERMAL STRESS

An applied force, caused by absorbed solar heat, that tends to strain or deform glass.

GLAZING

The work of installing glass in a frame.

GLAZING BEAD

A moulding or stop around the inside of a frame to hold the glass in place.

GLAZING COMPOUND

A soft dough-like material used for filling and sealing the space between a pane of glass and its surrounding frame.

HEAT GAIN

The transfer of heat from outside to inside. Both heat loss and heat gain are measured in terms of the fuel consumption required to maintain a comfortable indoor temperature.

HEAT LOSS REDUCTION

This is the ratio of the difference in heat loss through the glass after installing film to the heat loss through the glass with no film. It is expressed as a percentage and is determined by the respective "U" values of the glass with and without film.

HEATING DAYS

The number of days in a year that the heating equipment is used.

HEATING DEGREE-DAY

Heating and cooling engineers have found a way to relate the typical climate conditions of different areas to the amount of energy needed to heat and cool a building. The term they use is "Degree-Days" using a base temperature of 65°F (18°C). A heating degree-day is counted for each degree below 65°F (18°C) reached by the average (between the highest and lowest) daily outside temperatures in the winter. For example, if on a given winter day the high is 40°F (4°C) and the low is 20°F (-6°C), the daily average temperature is 30°F (-1°C). This is 35°F (19°C difference) below the base temperature of 65°F (18°C). So, on that day, you would have gone through 35 (19) heating degree-days.

HEAT LOSS

The transfer of heat from inside to outside by means of conduction, convection, and radiation through all surfaces of the building.

HEAT STRENGTHENED GLASS

Glass which is reheated, after forming, just below melting point and then cooled. A compressed surface is formed which increases its strength. Often used for spandrel glass.

HERMETICALLY SEALED UNIT

An insulated glass unit made up of two lites of glass, separated by a roll formed aluminum spacer tube (at the full perimeter) which is filled with a moisture absorbing material. The unit is then completely sealed, creating a moisture free, clean, dead air space.

HUMIDITY, RELATIVE

The percentage of moisture in the air in relationship to the amount of moisture the air could hold at that given temperature. 100% relative humidity would be rain.

HVAC

An abbreviation for Heating, Ventilating, and Air Conditioning equipment.

ICBO

International Conference of Building Officials.

INFILTRATION (air)

The movement of outdoor air into the interior of a building through cracks around windows and doors or in walls, roofs, and floors.

INSULATING GLASS

Insulating glass refers to two pieces of glass spaced apart and hermetically sealed to form a single-glazed unit with an air space between. Heat transmission through this type of glass may be as low as half that without such an air space. It is also called Double Glazing.

INTERIOR GLAZED

Glass set from the interior of the building.

INTERIOR STOP

The removable glazing bead that holds the glass in place, when it is on the interior side of the lite, as contrasted to an exterior stop which is located on the exterior side of a glass or panel.

JALOUSIE

The jalousie window is made up of horizontally-mounted louvered glass that abut each other tightly when closed and extend outward when cranked open.

KWH

An abbreviation for kilowatt-hour. A unit of electric power consumption. Equivalent to 3413 Btu's of energy or heat.
(1 kWh = 3.60 MJ)

LAMINATED GLASS

Two or more sheets with an inner layer of transparent plastic to which the glass adheres if broken. Used for overhead, safety glazing, and sound reduction.

LITE

Another term for a pane of glass used in a window. Frequently spelled "light" in the industry literature, but spelled "lite" in this text to avoid confusion with light as in "visible light".

LOW-EMISSIVITY GLASS

Glass which restricts the passage to radiant heat, in and out; a metal or metal oxide coating applied to the glass to provide low emissivity.

MAXIMUM HEAT GAIN

The maximum per hour amount of solar heat coming through one square foot of glass. Measured in units of Btu/hr/sq.ft. (W/m²).

MCF

An abbreviation of one thousand cubic feet. A unit of natural gas consumption. Equivalent to 1,000,000 Btu's (37,300 Kj/m³) of energy or heat.

MLB

An abbreviation for one thousand pounds. A unit of steam consumption. Equivalent to 1,000,000 Btu's (2330 Kj/kg) of energy or heat.

MOISTURE CONTROL

The use of humidifiers, air conditioners, or ventilation to keep the humidity of the home at acceptable levels. Also refers to vapor barriers.

MONOLITHIC

A single piece of glass.

MULLION

An intermediate connecting member used to "marry" two or more windows or patio doors together in a single rough opening without sacrificing air or watertight performance. A mullion also can give added strength to the connection for structural stability.

MUNTINS

A decorative design in cut-ups of glass lites. Examples:

- 1) Painted muntin grids (enamelite) applied to an interior lite of glass in a sealed insulated glass unit to simulate cut-ups of glass lites either in colonial or diamond patterns.
- 2) Use of aluminum muntin bar between lites of glass in a sealed insulated glass unit to simulate glass cut-ups.
- 3) Use of actual vertical and horizontal bars to divide windows into smaller lites of

glass. The bars are termed muntin bars.

NEOPRENE

A synthetic rubber having physical properties closely resembling those of natural rubber but not requiring sulphur for vulcanization. Extremely good weather resistance, both heat and cold, with ultraviolet stability.

NOAA

National Oceanic and Atmospheric Administration.

NON-FERROUS METALS

Metals or alloys that are free of iron, such as aluminum.

OBSCURE GLASS

Mainly used for decoration, diffusion, or privacy. The design is pressed into the glass during the rolling process. There are many patterns available.

ORGANIC COATING

A coating such as paint, lacquer, enamel, or plastic film in which the principal ingredients are derived from animal or vegetable matter or from some compound of carbon (which includes all plastics).

PASSIVE SOLAR HEAT GAIN

Solar heat that passes through a material and is captured naturally, not by mechanical means. (ex Large windows facing south will take advantage of passive solar heat gain in Northern Hemisphere.)

PAYBACK

Savings from reducing energy cost and seeing this reflected in your heating/cooling bills

PERMEABILITY

The quality of permitting passage of water through openings without causing rupture or displacement

PLATE GLASS

Polished plate glass is a rolled, ground, and polished product with true flat parallel plane surfaces

POLYCARBONATE

Any of a family of thermoplastics characterized by a high softening temperature and high impact strength (Lexan).

POLYSULFIDE

Polysulfide liquid polymers are mercaptan

terminated, long chain aliphatic polymers containing disulfide linkages. They can be converted to rubbers at room temperature without shrinkage upon addition of a curing agent. Used for exterior sealant and sealed insulating glass sealant.

PSF

Pounds per square foot (lbs/ft²) (kg/m²) - Abbreviation of pressure notation, used to describe wind pressure, barometric pressure.

PSI

Pounds per square inch - (lbs/in²) (kg/cm²) as above.

PSYCHROMETER

An apparatus used to determine the relative humidity by determining the wet bulb temperature of the air. It is a very accurate means of determining relative humidity.

RADIATION

Transmission of heat through space by wave motion; passage of heat from one object to another without warming the space between, such as sun light.

REFLECTANCE

The fraction of the incident light that is reflected.

RELATIVE HEAT GAIN

The amount of conduction heat gain plus solar heat gain, measured in terms of energy units per hour per square foot (compare U-Value). (Btu/hr/sq.ft. or W/m²).

RFI

An abbreviation for Radio Frequency Interference.

ROI

Return on investment.

“R”-VALUE

A measure of resistance to heat gain or loss (insulative ability). “R”-Values rather than thicknesses can be compared for different materials, since 6" (152mm) of fiberglass (R-19 [R-34]) might compare with 12" (305mm) of wood or 18' (15.5m) to stone. “R”-Value of some common substances of 1" (25mm) thickness:

Concrete	0.1	(0.018)
Stucco and brick	1.2	(0.21)
Plywood	1	(0.18)
Sawdust	2	(0.36)

Fiberglass batts	3	(0.54)
Polystyrene	6.25	(1.10)
Polyurethane foam	7.7	(1.36)

SBCC

Southern Building Code Congress International.

SEALANT

An elastomeric material with adhesive qualities that joins components of a similar to dissimilar nature to provide an effective barrier against the passage of the elements.

SHADING COEFFICIENT

This is a ratio of the solar energy entering through a window compared to that which enters through a window of clear 1/8" (3mm) double strength sheet glass. The solar energy which enters includes both that which is transmitted directly through the window and that portion of the energy absorbed in the window that is transferred to the interior.

SHEET GLASS

A transparent, flat glass whose surface has a characteristic waviness. There are three basic classifications of sheet glass

- 1) Single strength (S.S.): 3/32" (2.4mm) thick.
- 2) Double strength (D.S.): 1/8" (3.2mm) thick.
- 3) Heavy sheet which has three available thicknesses 3/16" (4.8mm), 7/32" (5.6mm), and 1/4" (6.4mm).

SHELF LIFE

The length of time that packaged materials such as adhesives and sealants can be stored under specific temperature conditions and still remain suitable for use.

SIG

(Sealed Insulated Glass) - See insulating glass.

SOLAR ENERGY SPECTRUM

Solar radiation is typically divided into three categories, namely, the ultraviolet, the visible and the near infrared portions of the spectrum. All three portions result in heat when the solar radiation is absorbed. At the earth's surface, approximately 3% of the solar energy is in the ultraviolet portion, 44% is in the visible portion and 53% is in the near infrared.

SOLAR HEAT GAIN

The amount per hour of solar heat coming through a square foot of glass Measured in units of Btu/hr/sq.ft. (W/m²).

SOLAR HEAT REDUCTION

This is the ratio of the difference in total solar energy entering before and after installing film on the glass to that entering through the glass with no film. It is expressed as a percentage and is determined by the respective shading coefficients of the glass with and without film.

SPANDREL GLASS

Heat-strengthened float glass with a colored-ceramic coating adhered to the back by a heat-fusing process. It has double the strength of annealed glass of the same size and thickness; enabling it to withstand greater uniform loads and thermal stresses. Spandrel glass cannot be re-cut after heat strengthening. It is used as fixed opaque colored glass on buildings in front of floor slabs and columns. It is available in a wide array of colors.

SPECTROPHOTOMETER

An instrument for measuring the transmittance and reflectance of surfaces and media as a function of wavelength.

SUNLIGHT

The portion of solar energy which is detectable by the human eye; it accounts for about 44% of the total solar energy.

TEMPERED GLASS

As with heat strengthened glass, it is reheated to just below the melting point but suddenly cooled. When shattered, it breaks into small pieces. It is approximately five times stronger than standard annealed glass. It must be used as safety glazing in patio doors, entrance doors, side lites, and

other hazardous locations. It can't be re-cut after tempering.

TENSILE STRENGTH
(Also called ultimate strength)

The breaking strength of a material when subjected to a tensile (stretching) force. Usually measured by placing a standard piece in the jaws of a tensile machine gradually separating the jaws and measuring the stretching force necessary to break the test piece. Tensile strength is commonly expressed as pounds (or tons) per square inch (kg/m²) of original cross sectional area.

THERM

100,000 Btu's (105.5 MJ) to energy or heat.

TINTED GLASS

A mineral admixture is incorporated in the glass, resulting in a degree to tinting. Any tinting reduces both visual and radiant transmittance.

TON-HR

A unit to air conditioning consumption equivalent to 12,000 Btu's (3024kcal) to energy.

TOTAL SOLAR ENERGY

When solar radiant energy strikes the exterior surface of a window, the energy is reflected, absorbed and/or transmitted as defined above. The total of these three parameters must add up to 100%.

TOTAL SOLAR ENERGY ABSORBED

This is a ratio of the solar energy that is absorbed by the window and converted to heat in the window to the total solar energy impinging on the window. It is typically expressed as a percentage.

TOTAL SOLAR ENERGY REFLECTED

This is a ratio to the solar energy that is reflected directly away by the window to the

total solar energy impinging on the window. It is typically expressed as a percentage.

TOTAL SOLAR ENERGY TRANSMITTED

This is a ratio to the solar energy that is transmitted directly through the window where it is absorbed by interior surfaces to the total solar energy impinging on the exterior window surface. It is typically expressed as a percentage.